

**Color the pictures that begin with the
sound of the letter A**

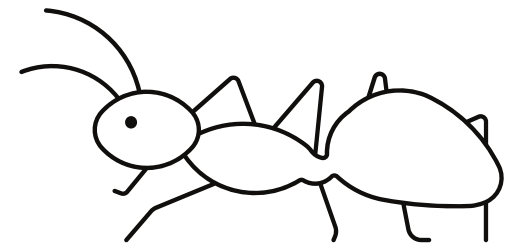

Color the pictures that begin with the
sound of the letter B

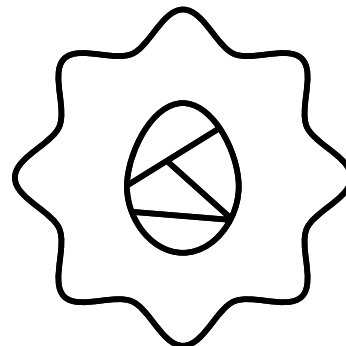
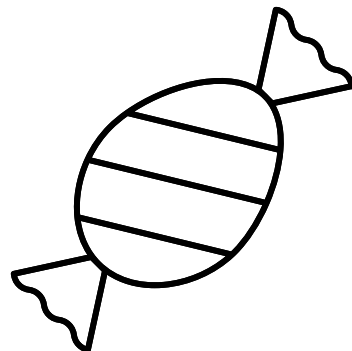
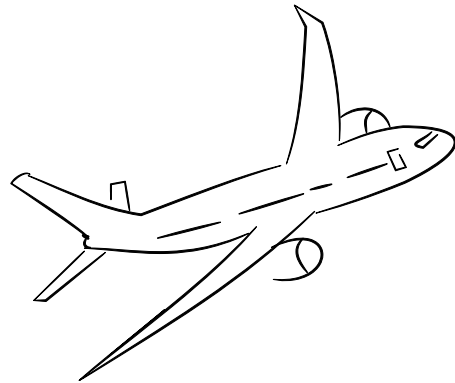
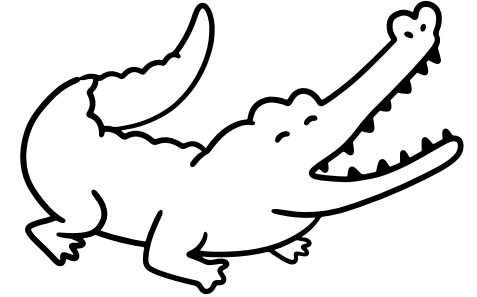
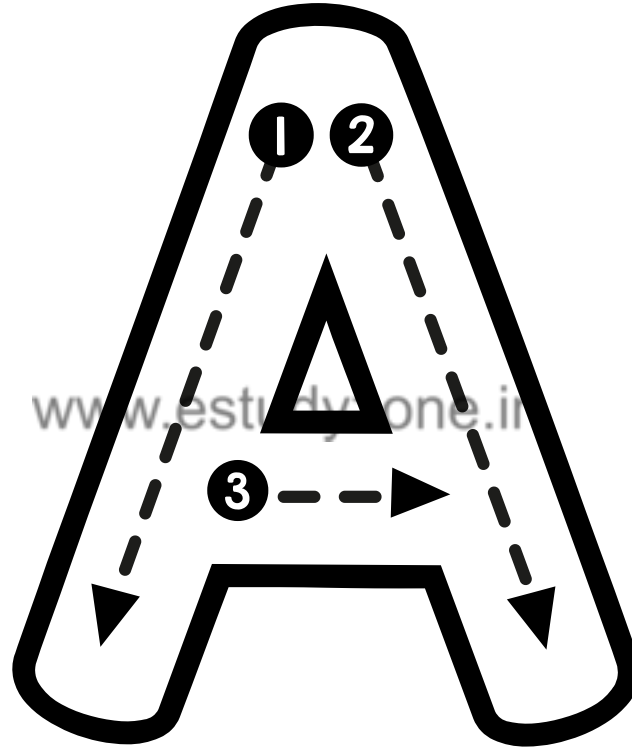
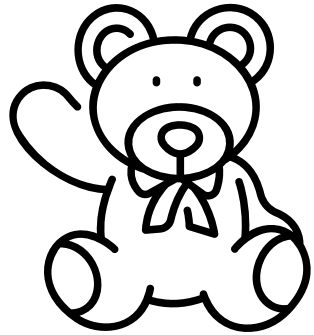
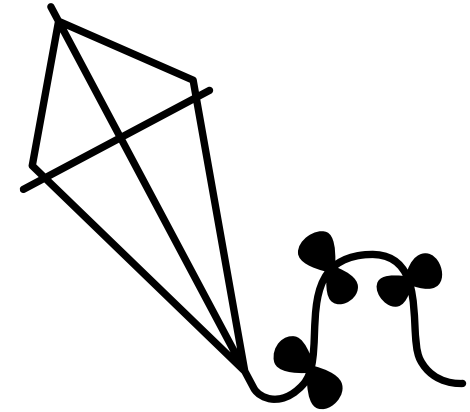
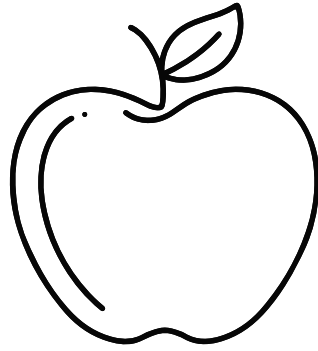
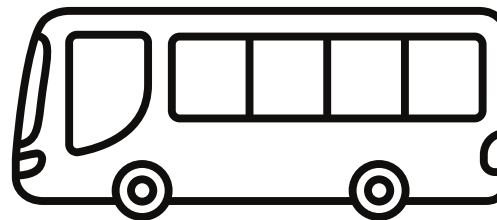
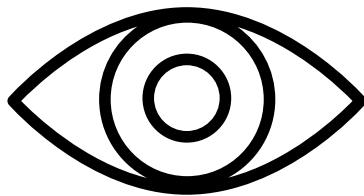
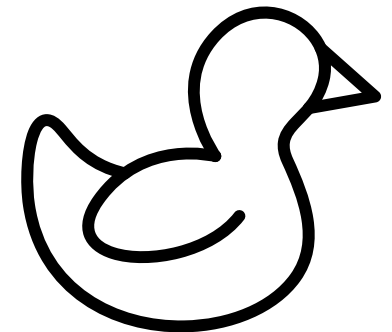
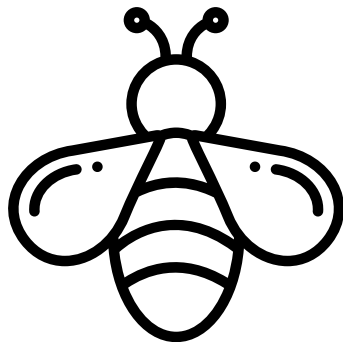
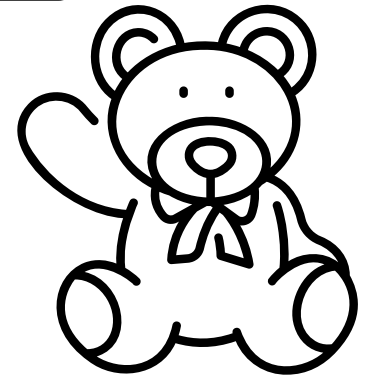
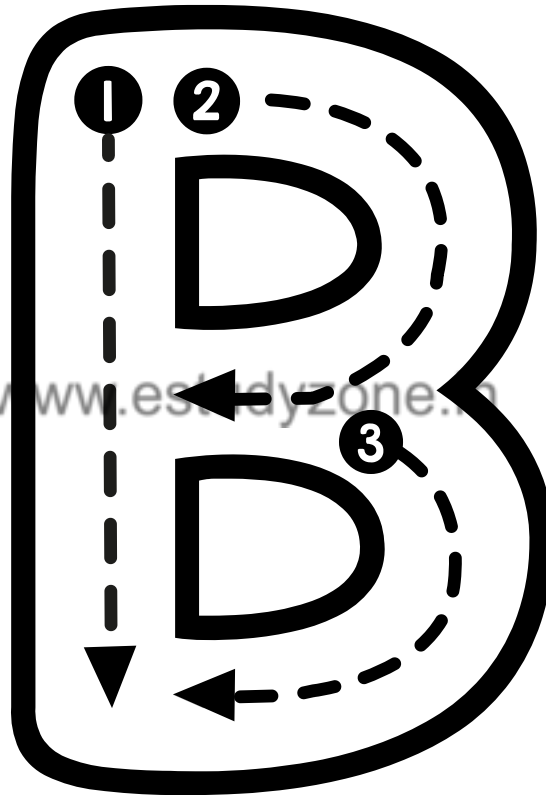
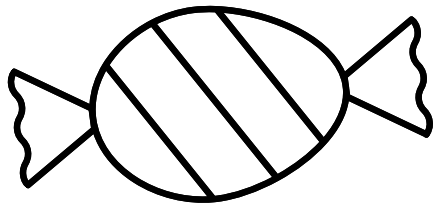
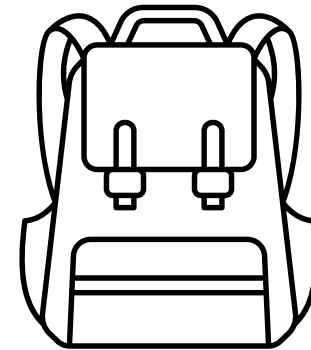
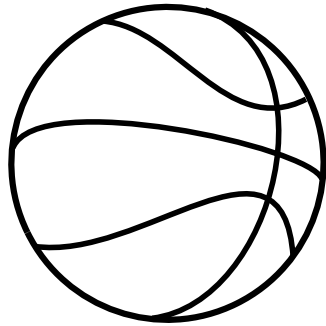

**Color the pictures that begin with the
sound of the letter C**

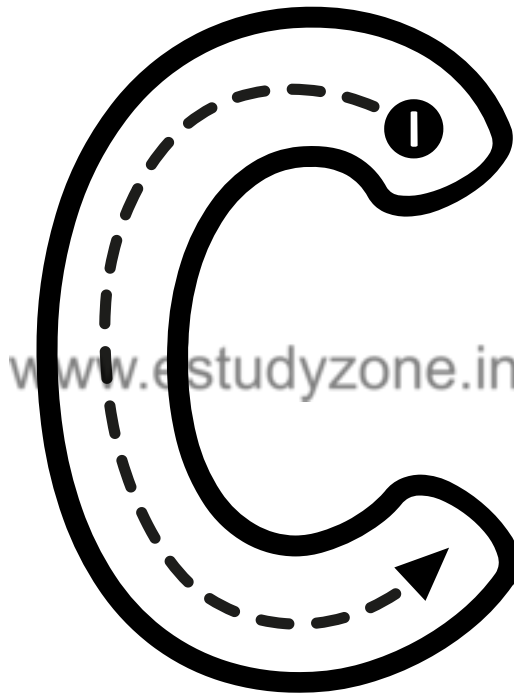
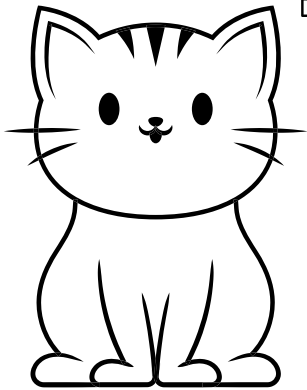
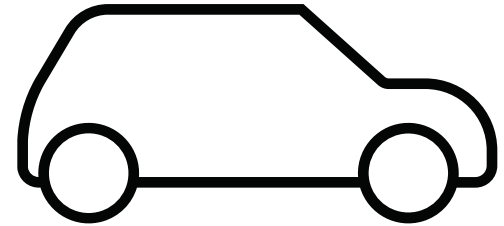
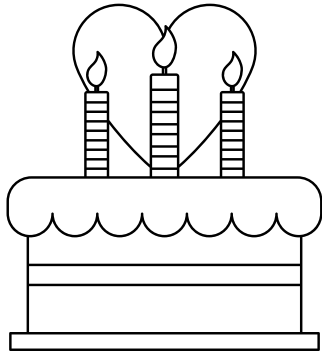

www.studyzone.in

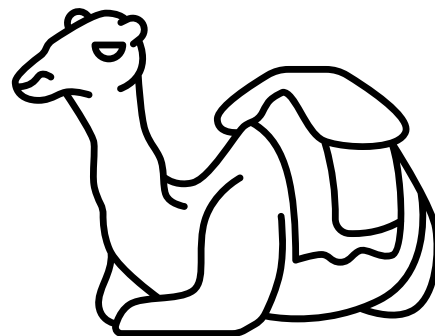
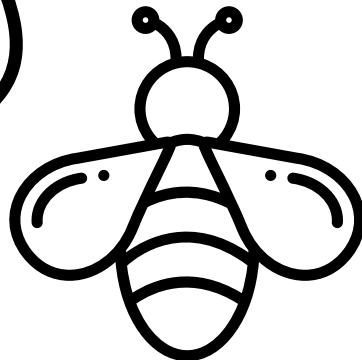
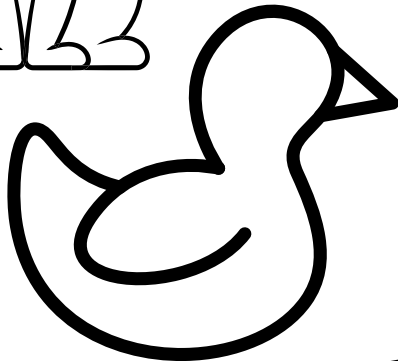
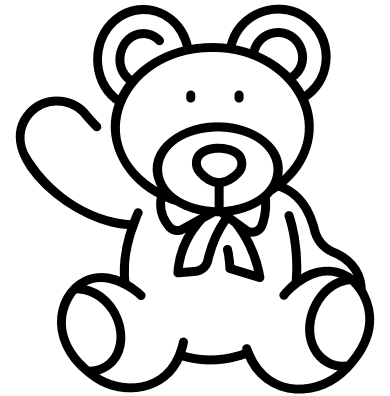

Color the pictures that begin with the
sound of the letter D

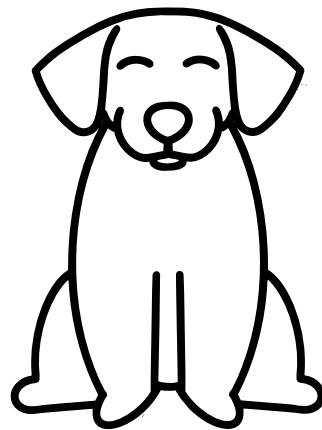
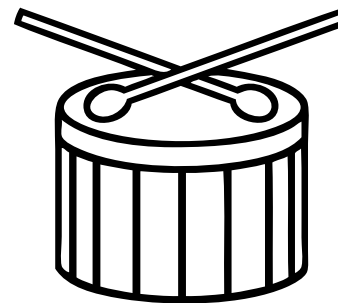
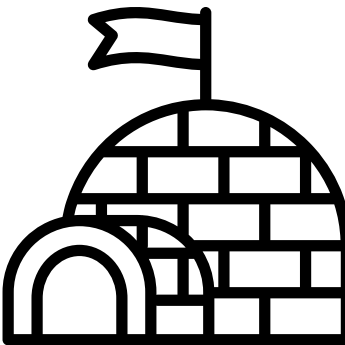
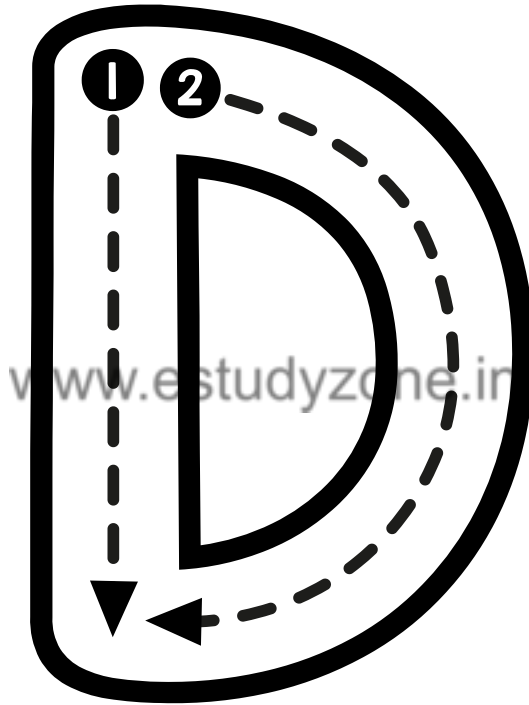
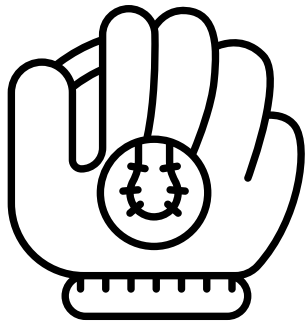
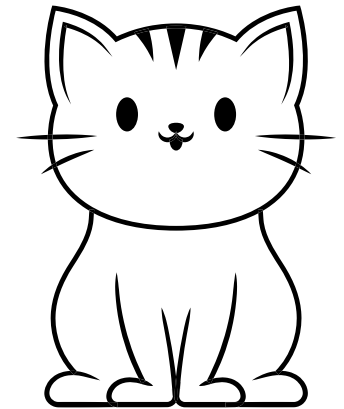
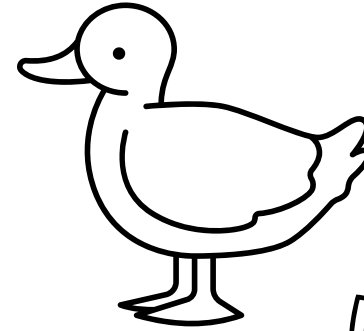
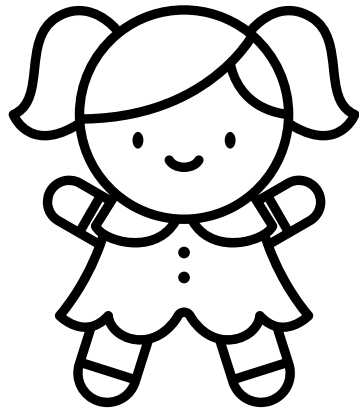

**Color the pictures that begin with the
sound of the letter E**

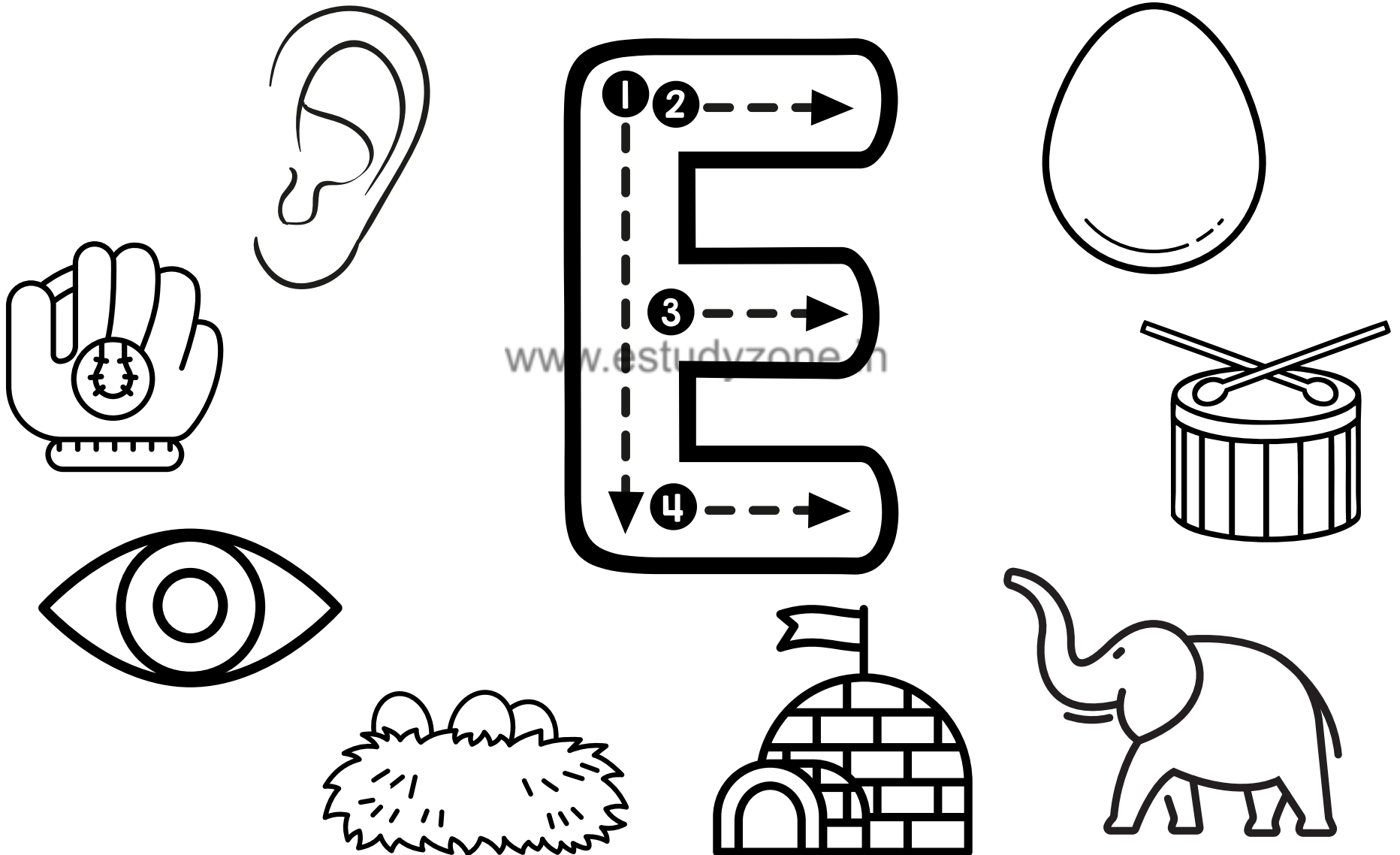

Color the pictures that begin with the
sound of the letter F

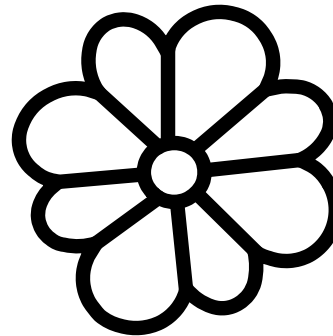
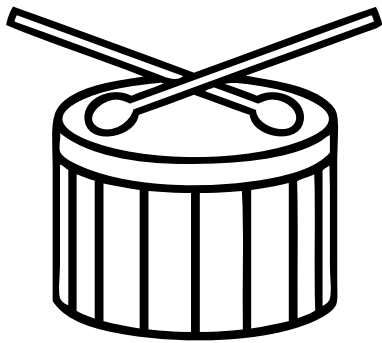
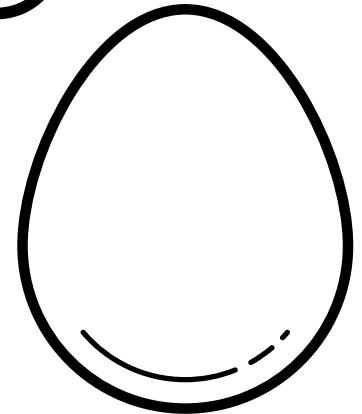
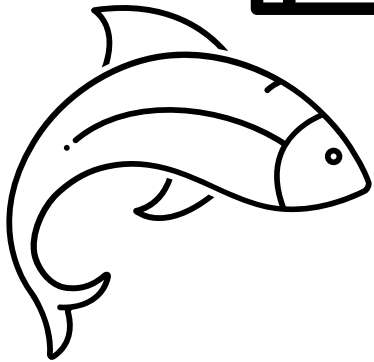
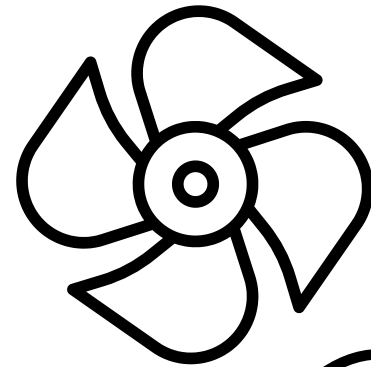
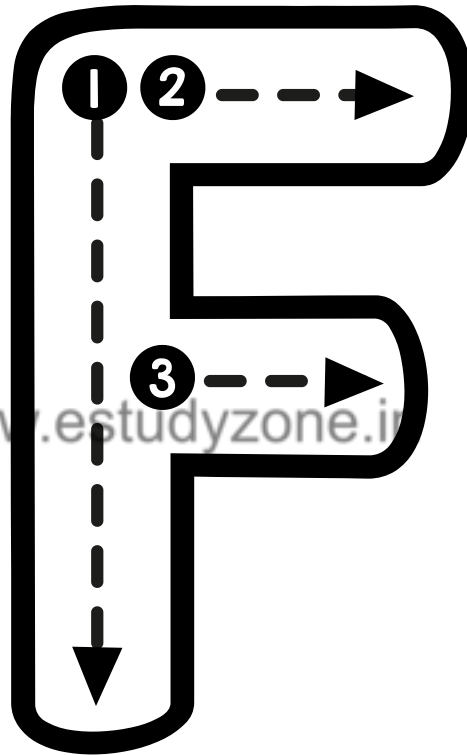
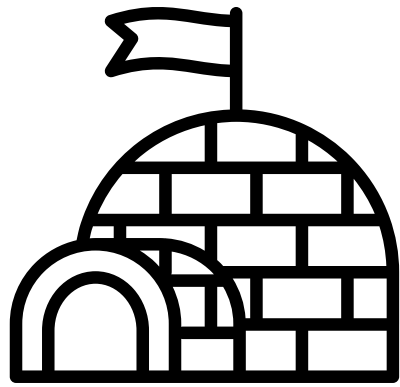

**Color the pictures that begin with the
sound of the letter G**



Color the pictures that begin with the
sound of the letter H

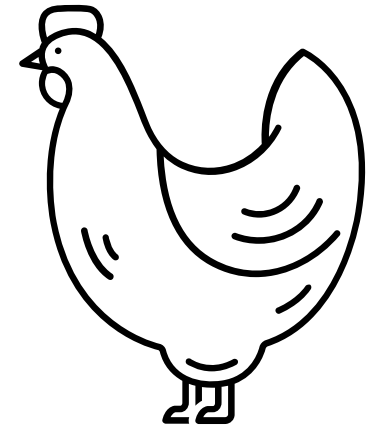
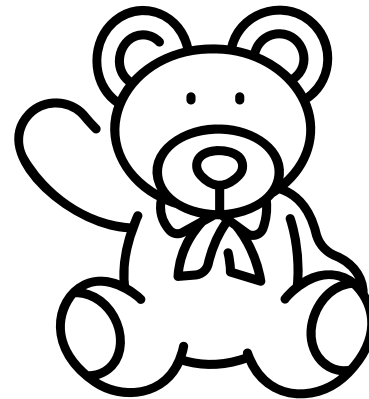
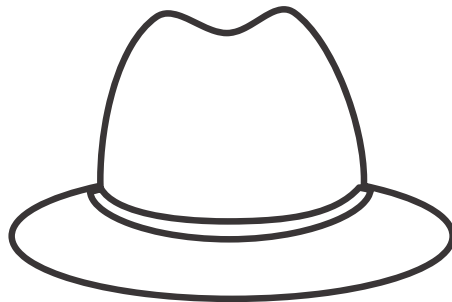
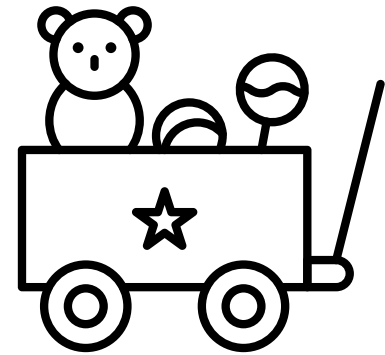
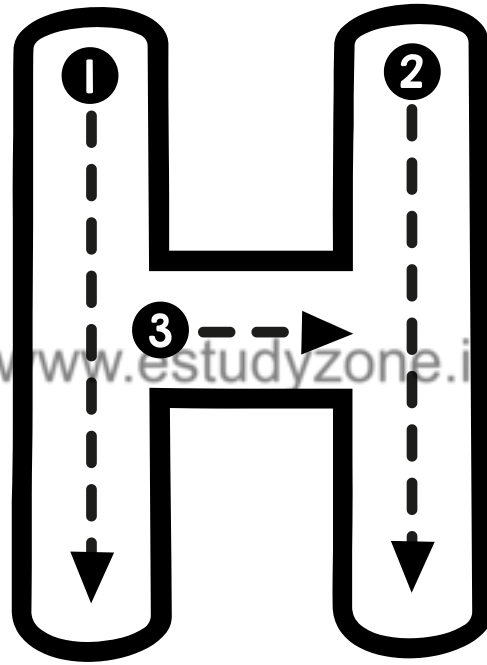
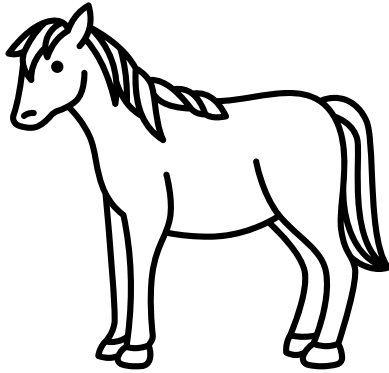

**Color the pictures that begin with the
sound of the letter I**

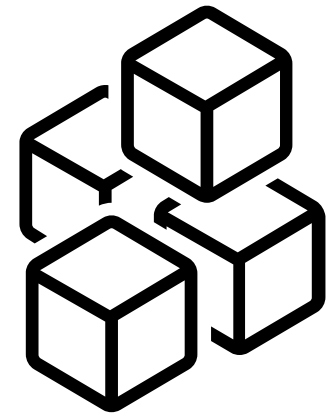
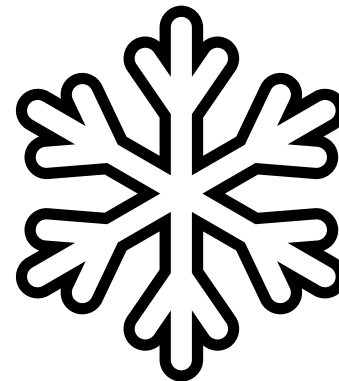
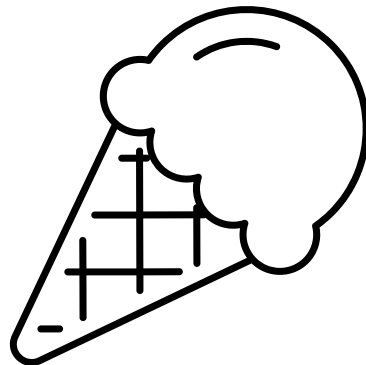
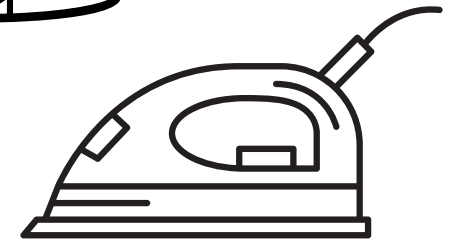
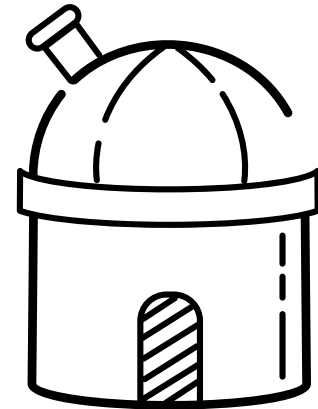
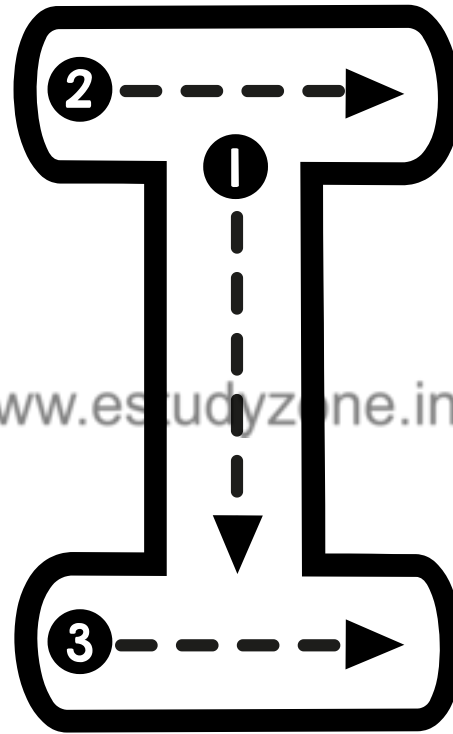
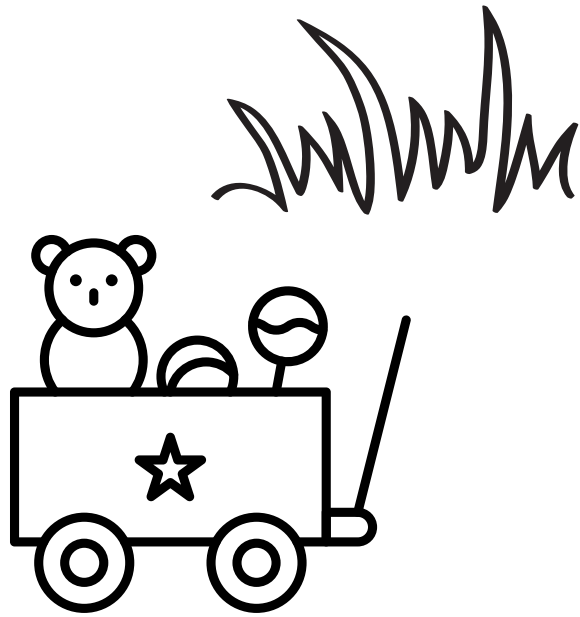

www.estudyzone.in

**Color the pictures that begin with the
sound of the letter J**

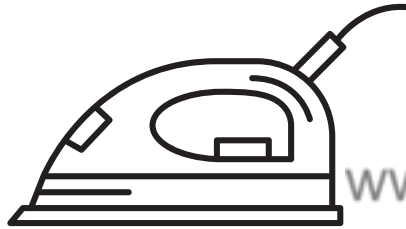
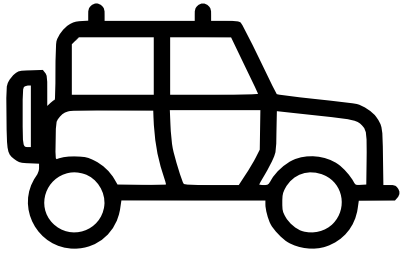

www.estudyzone.in

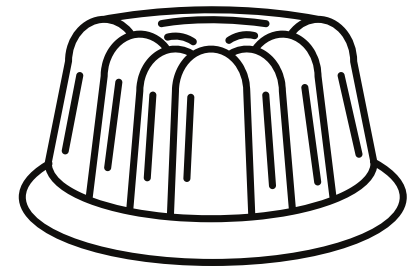
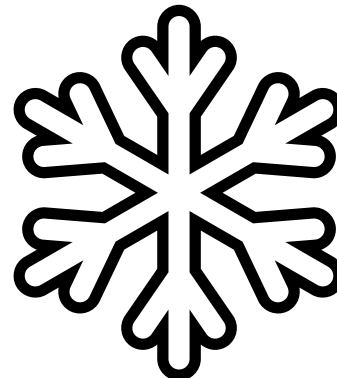
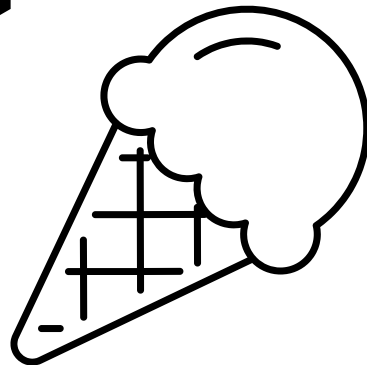
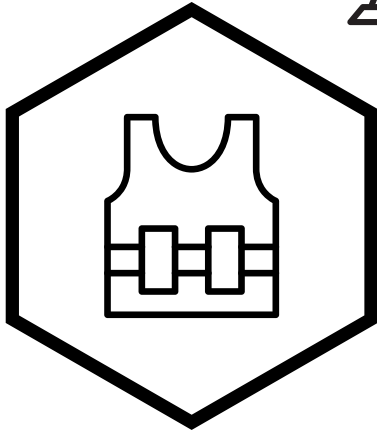
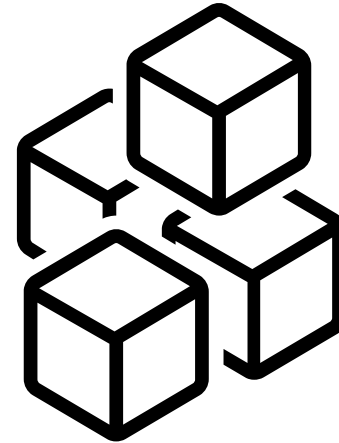

**Color the pictures that begin with the
sound of the letter K**

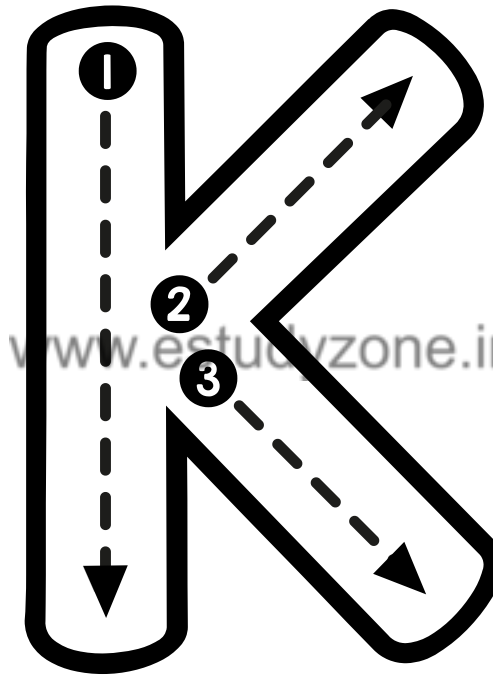
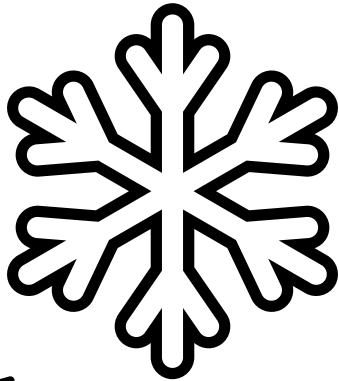
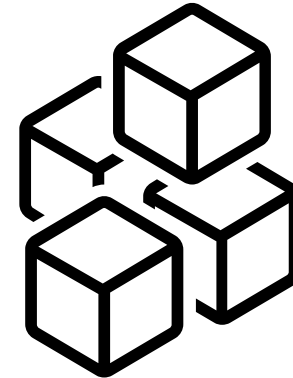
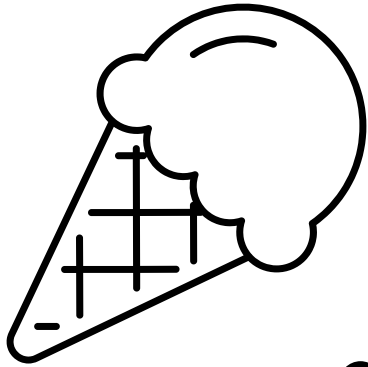

www.estudyzone.in

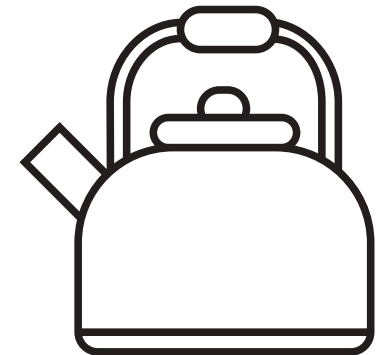
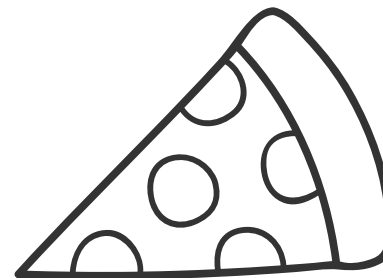
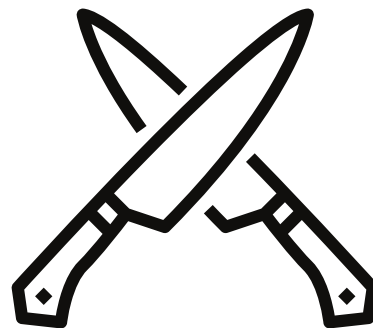
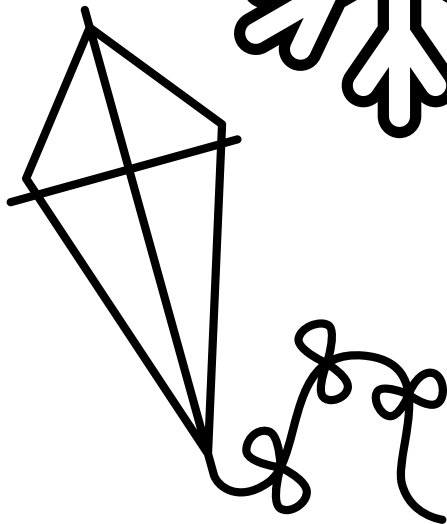

**Color the pictures that begin with the
sound of the letter L**

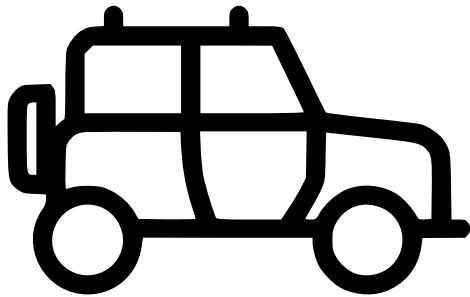
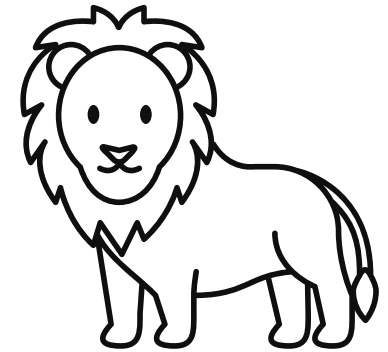
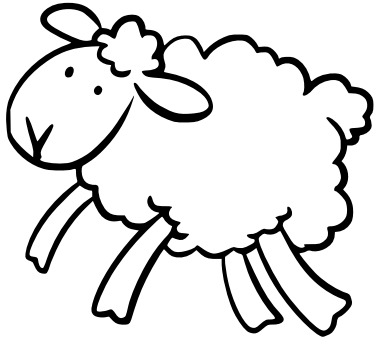

www.estudyzone.in

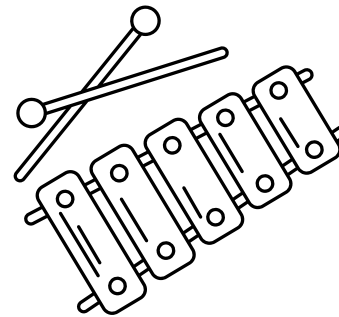
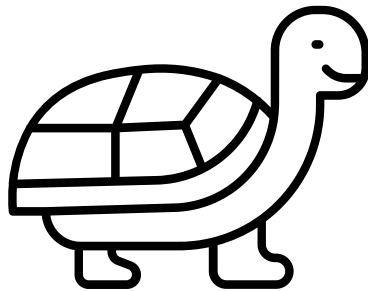
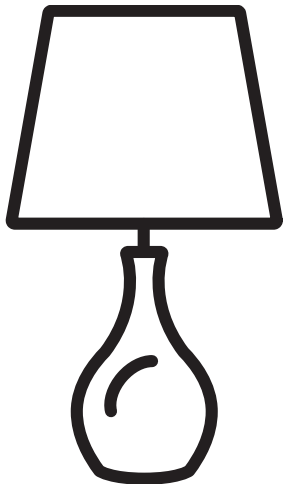
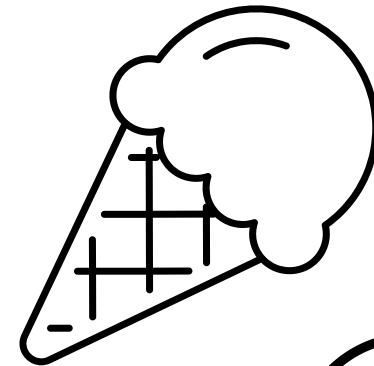
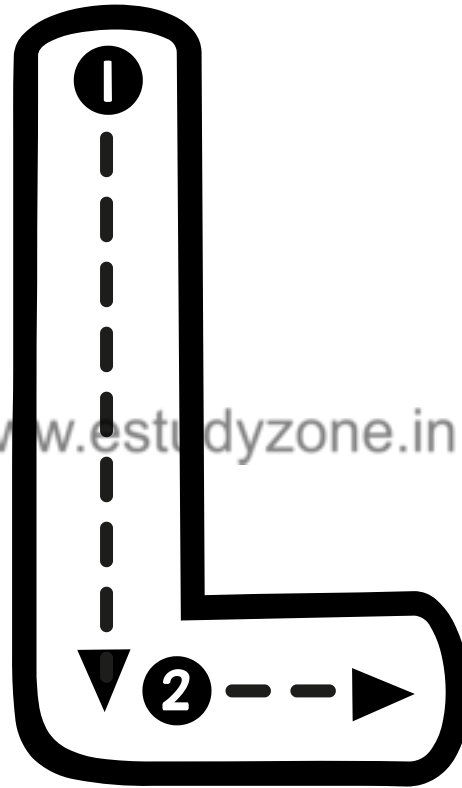

**Color the pictures that begin with the
sound of the letter M**

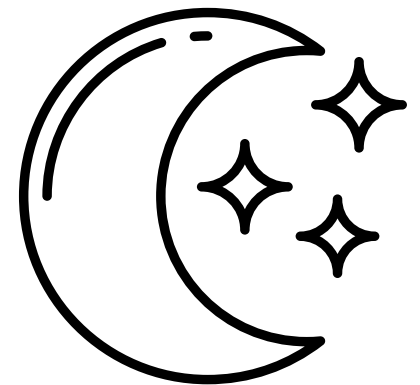
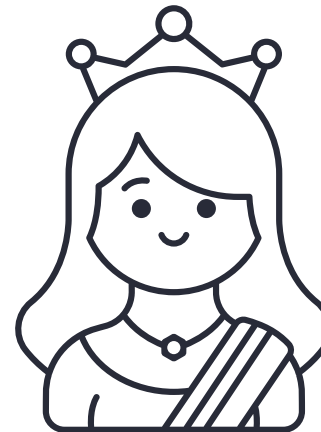
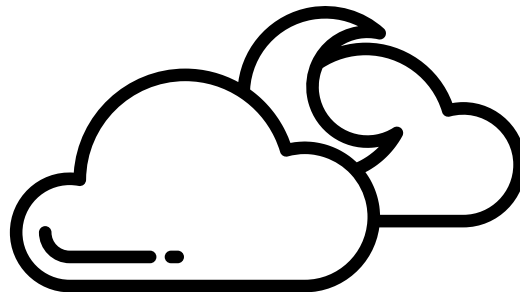
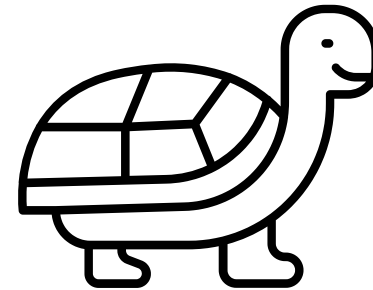
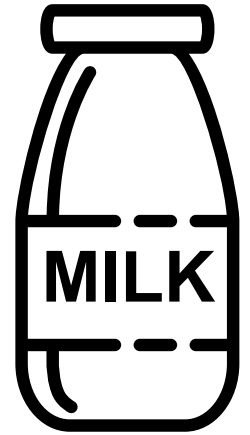
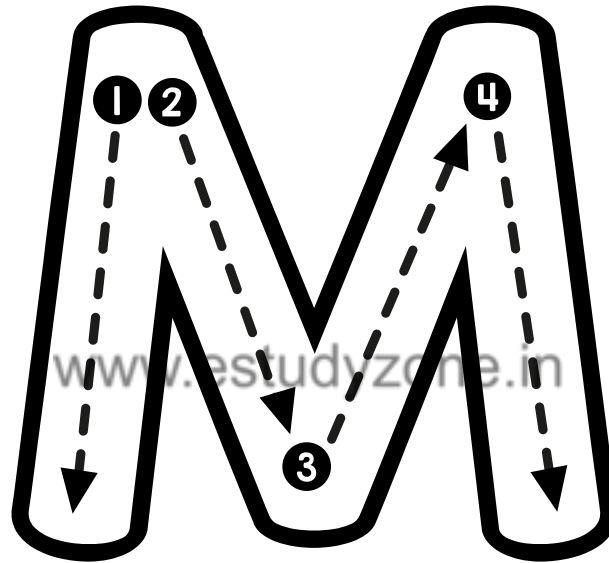
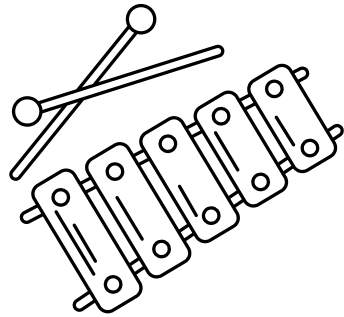
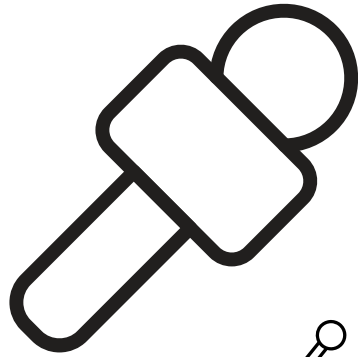

Color the pictures that begin with the
sound of the letter N

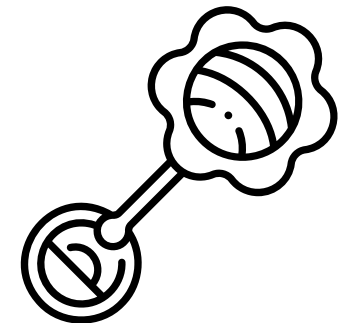
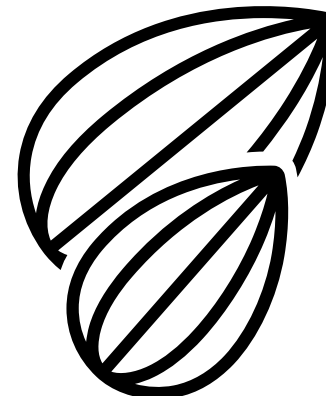
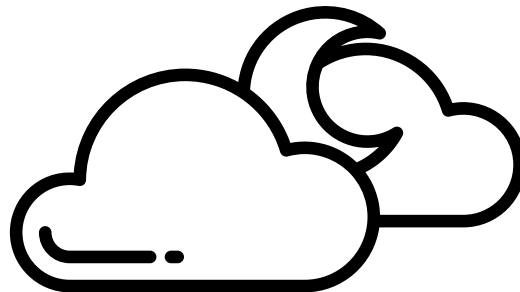
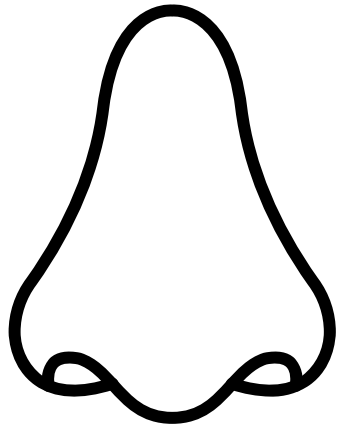
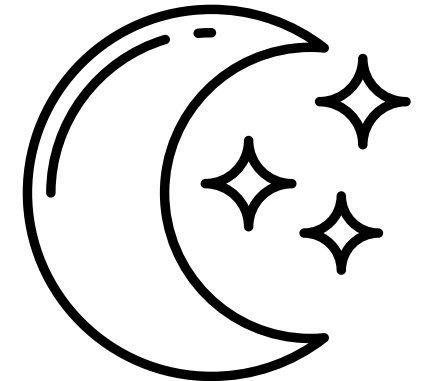
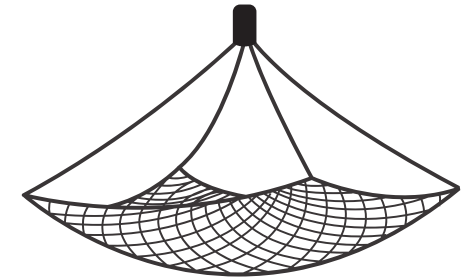
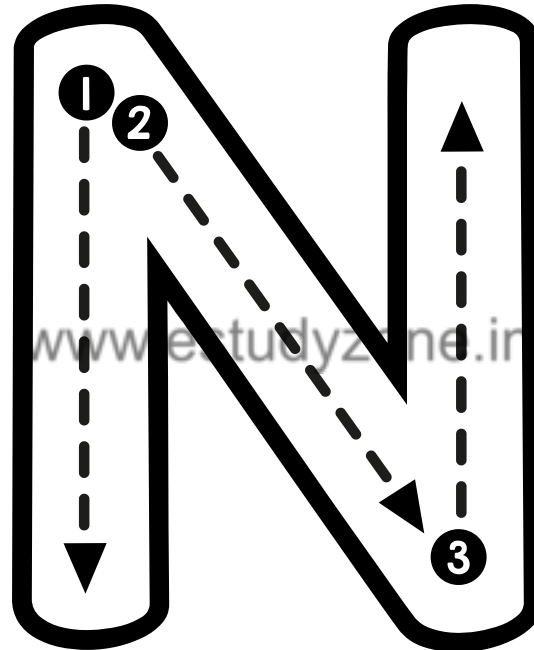
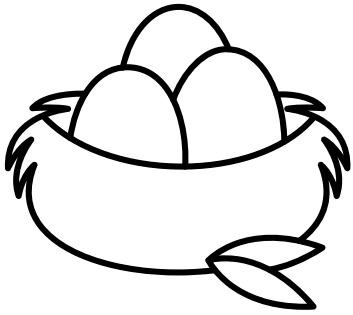

**Color the pictures that begin with the
sound of the letter O**

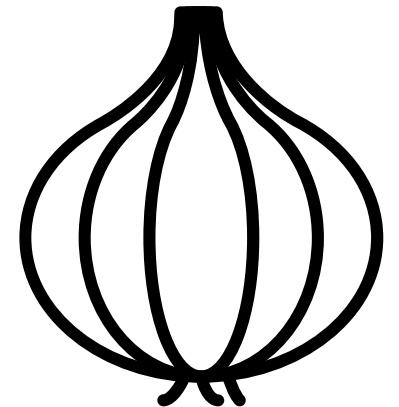
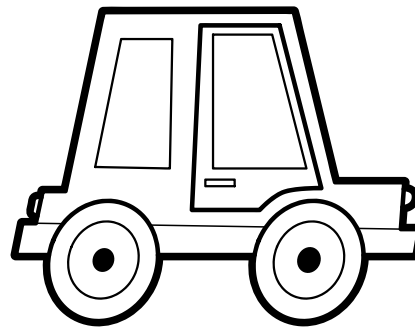
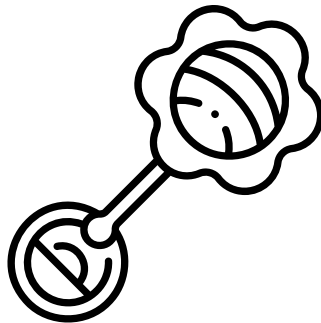
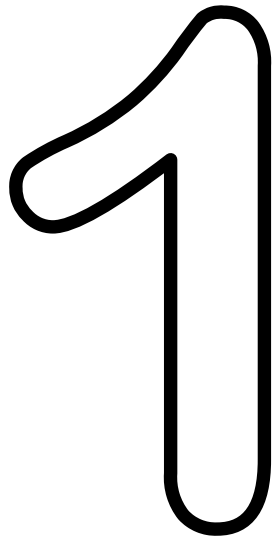
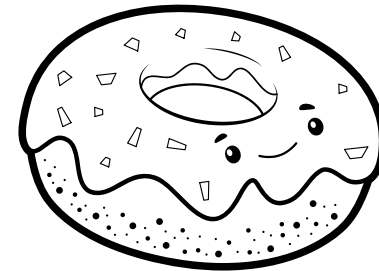
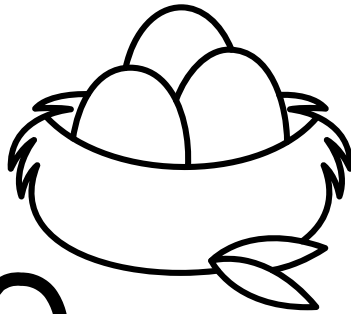
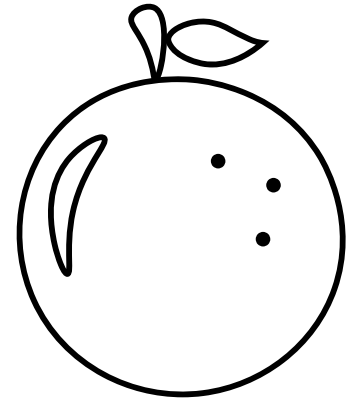
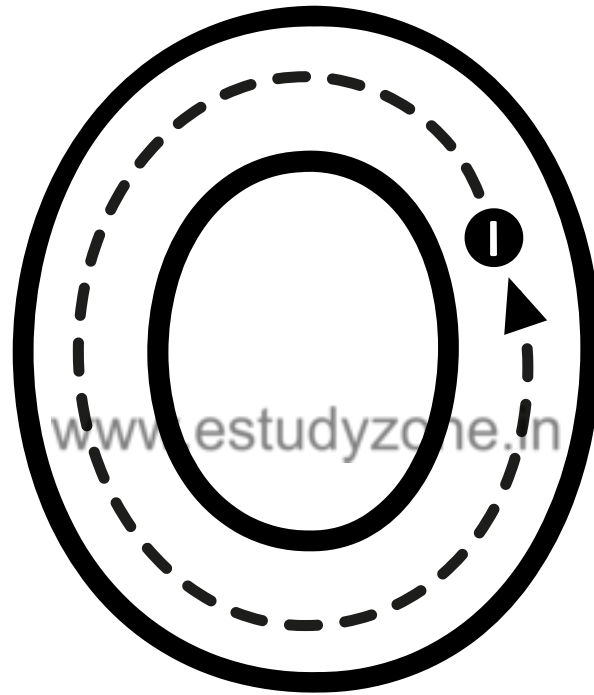
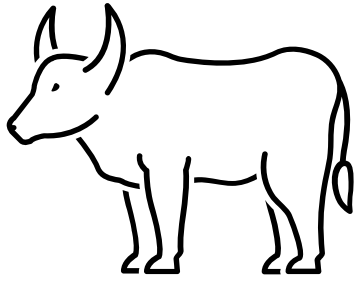

Color the pictures that begin with the
sound of the letter P

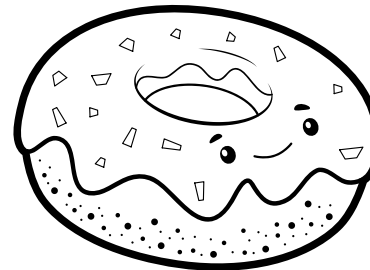
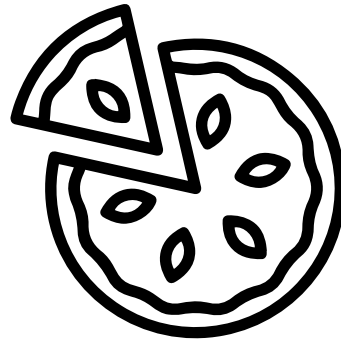
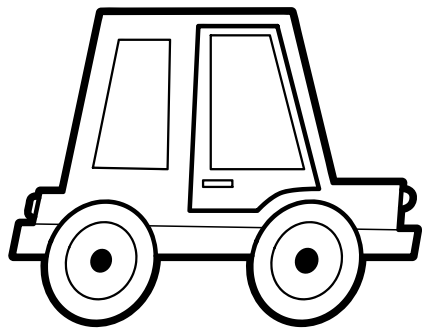
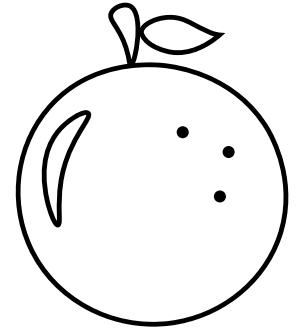
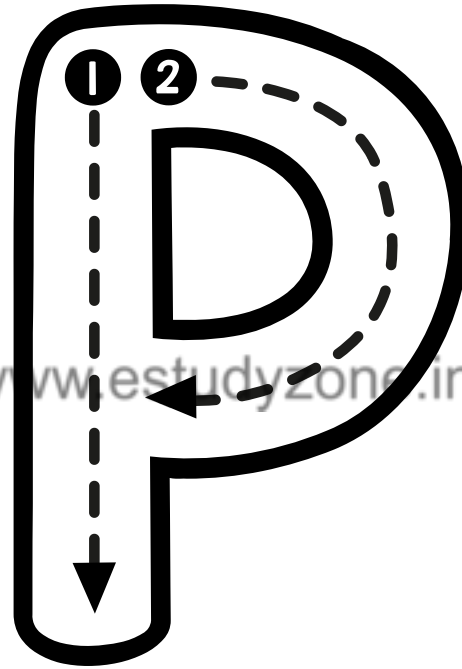
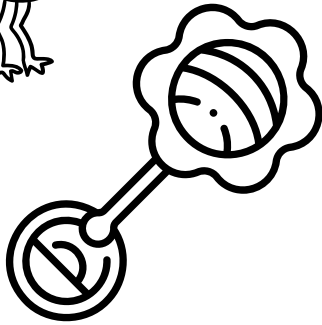
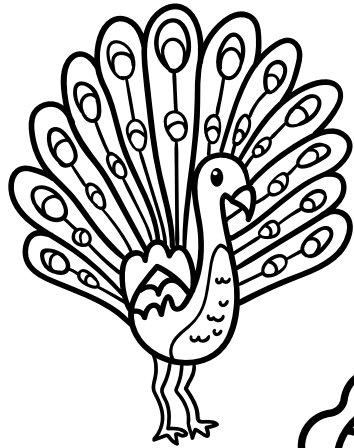

Color the pictures that begin with the
sound of the letter Q,

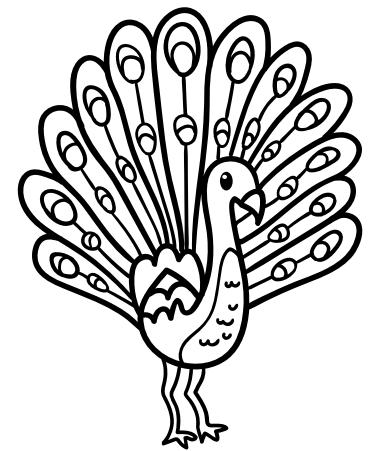
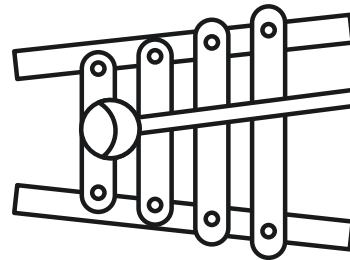
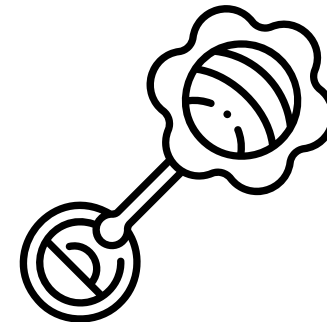
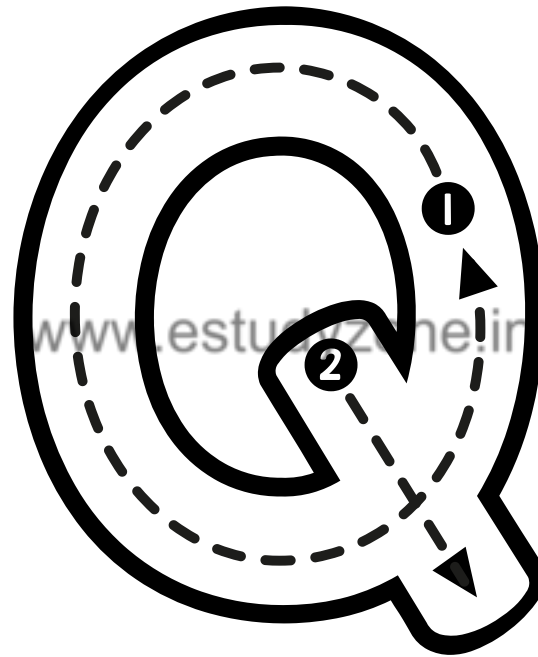
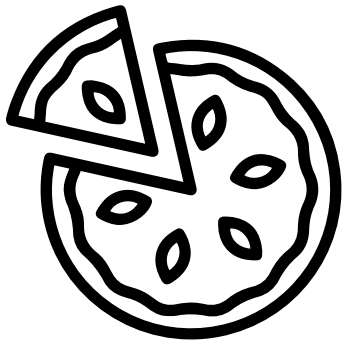
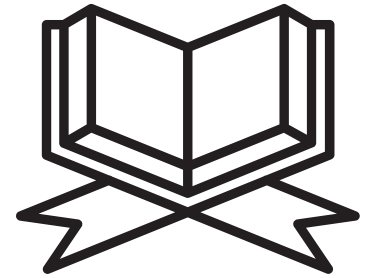
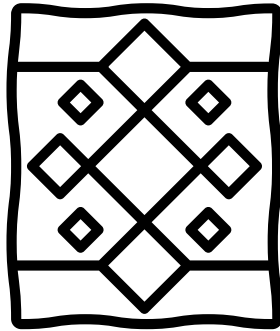

**Color the pictures that begin with the
sound of the letter R**

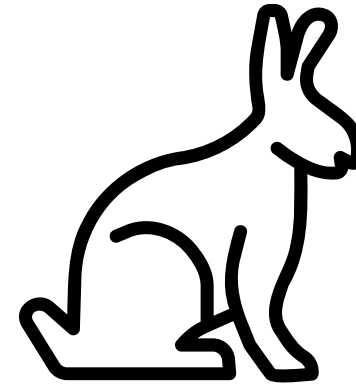
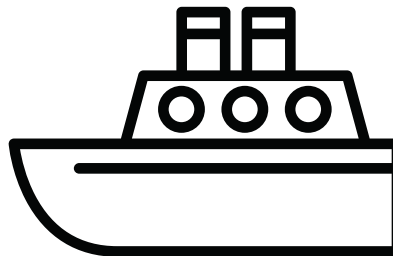
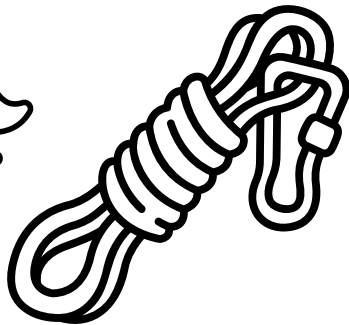
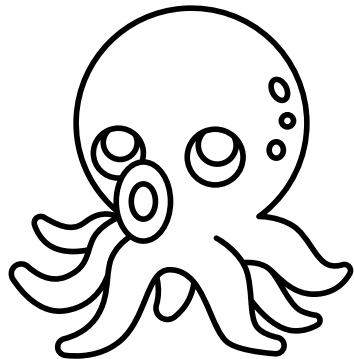
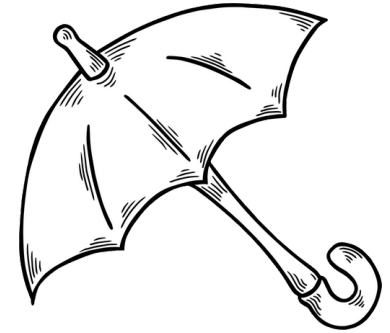
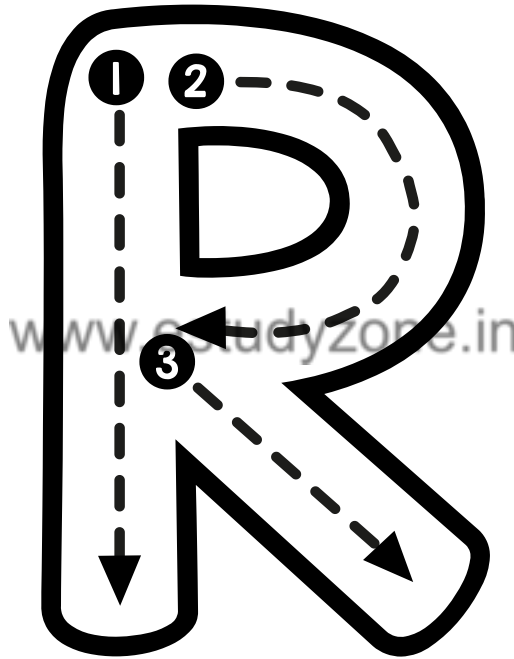
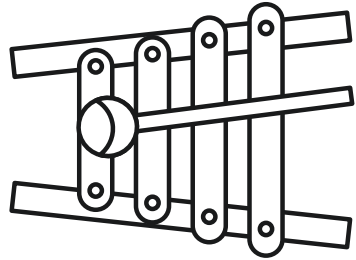
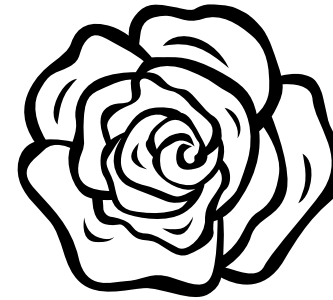

**Color the pictures that begin with the
sound of the letter S**

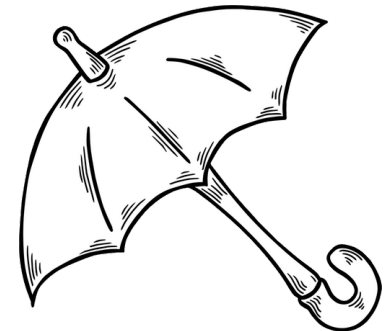
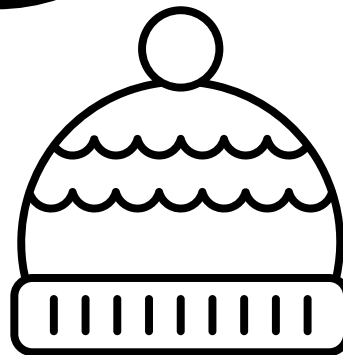
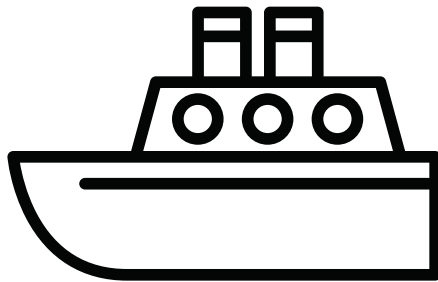
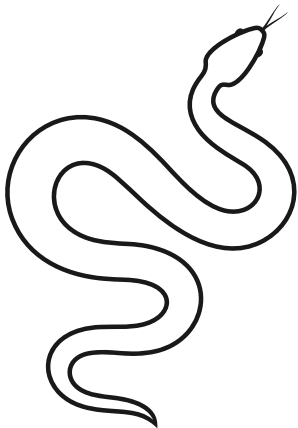
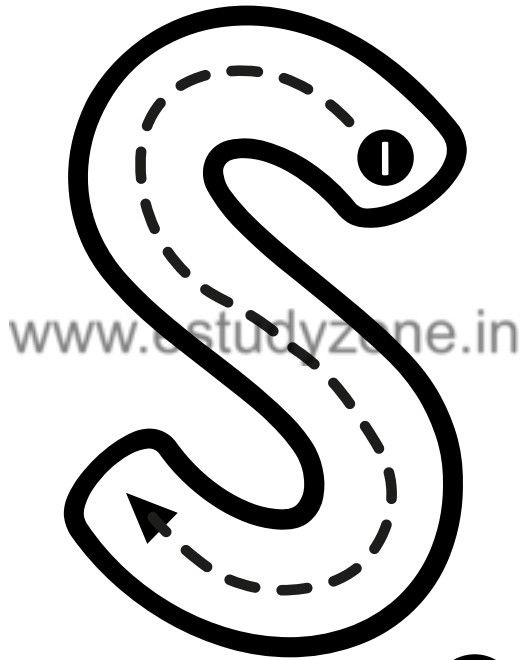
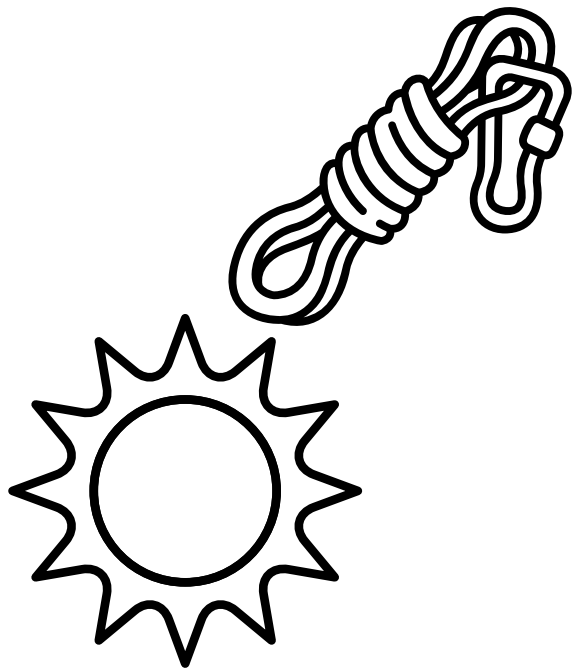

www.estudyzone.in

**Color the pictures that begin with the
sound of the letter T**

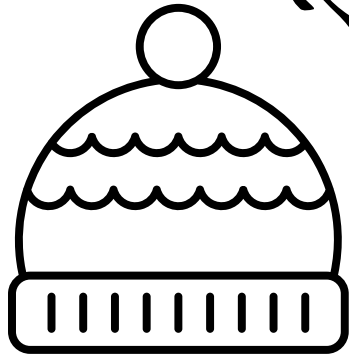
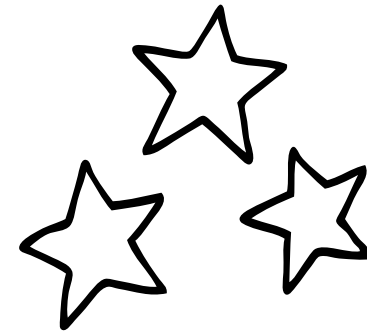
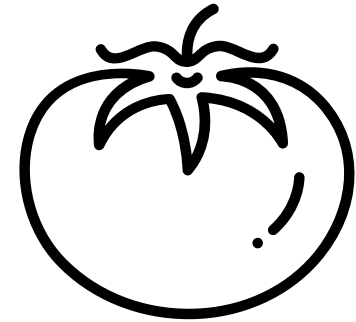
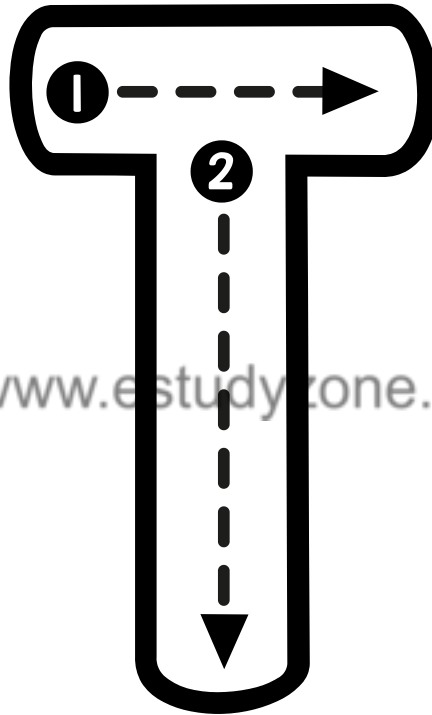

www.estudyzone.in

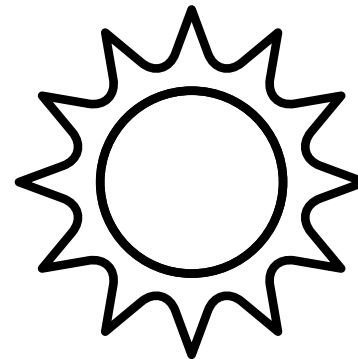
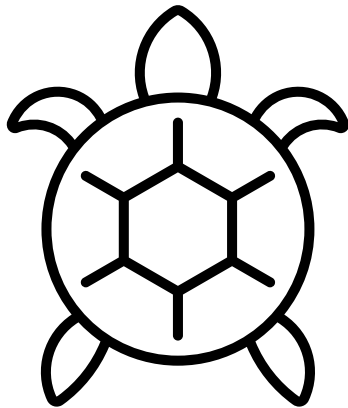

**Color the pictures that begin with the
sound of the letter U**

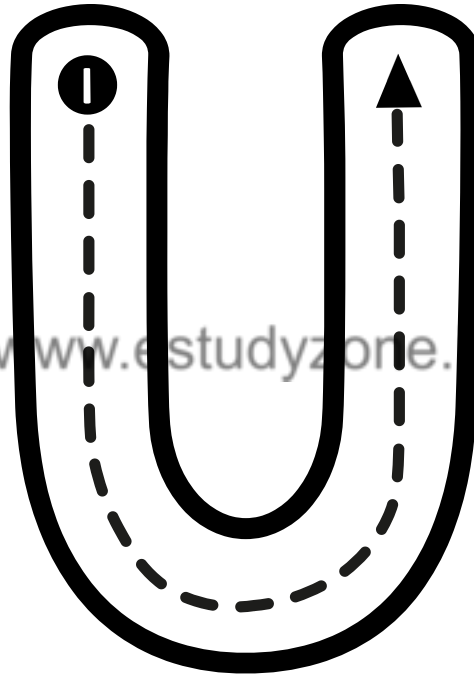
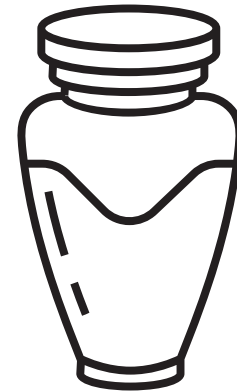
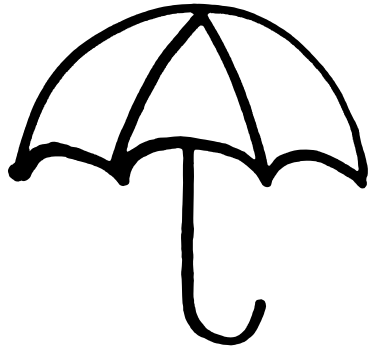

www.estudyzone.h

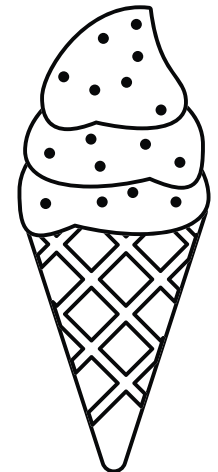
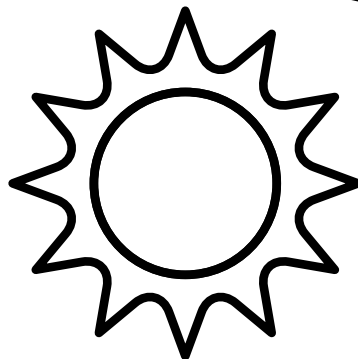
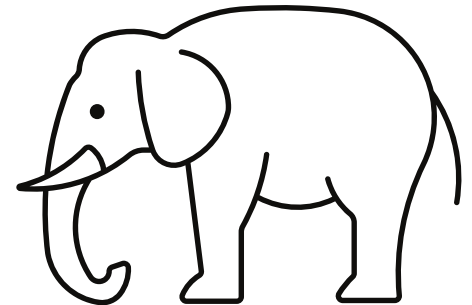

**Color the pictures that begin with the
sound of the letter V**

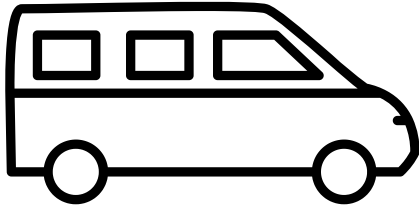
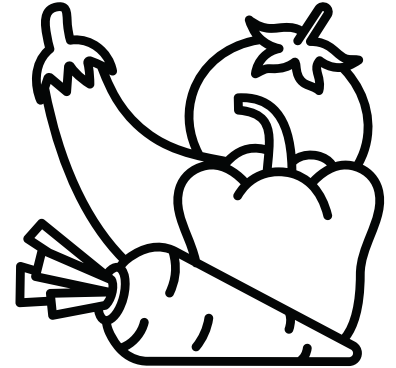
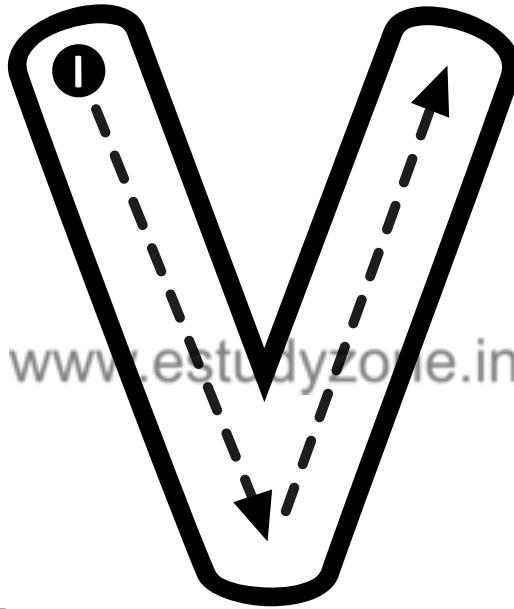
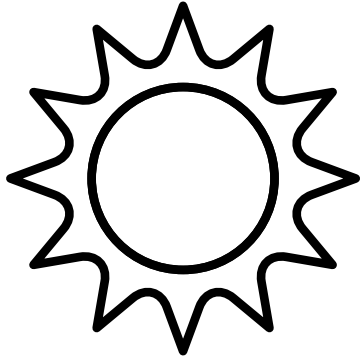

www.estudyzone.in

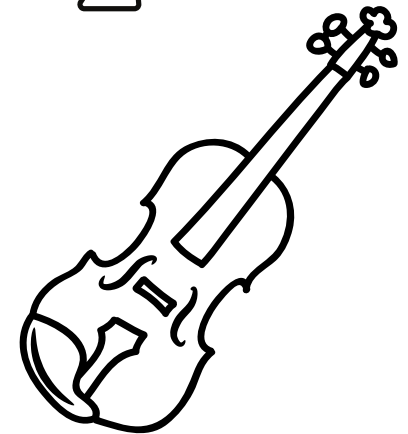
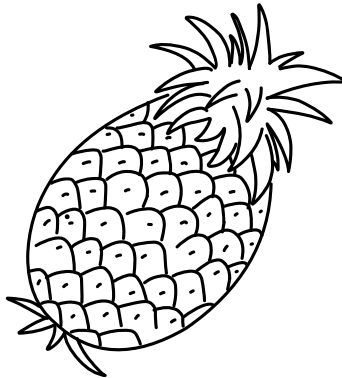
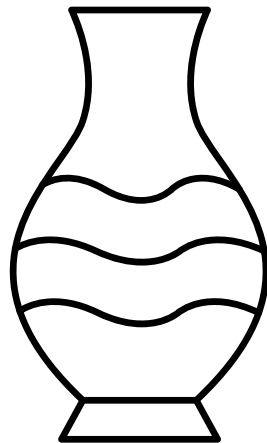
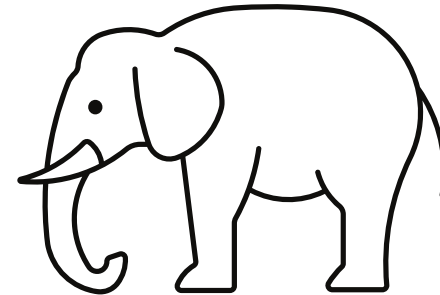

**Color the pictures that begin with the
sound of the letter W**

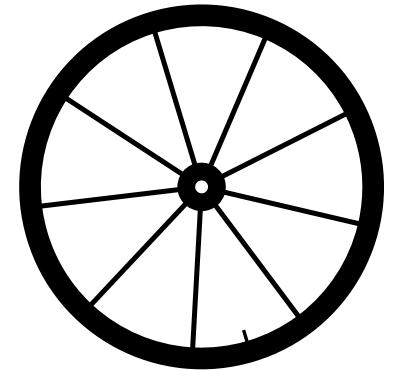
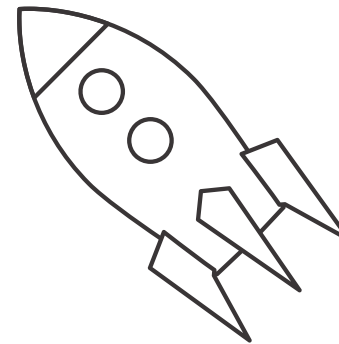
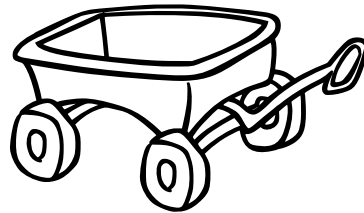
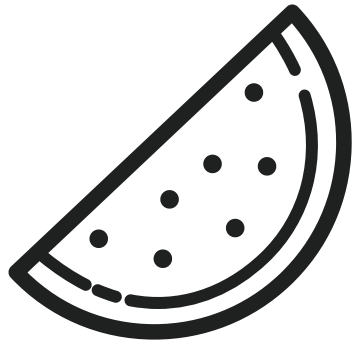
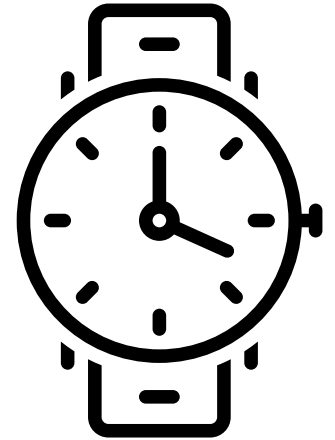
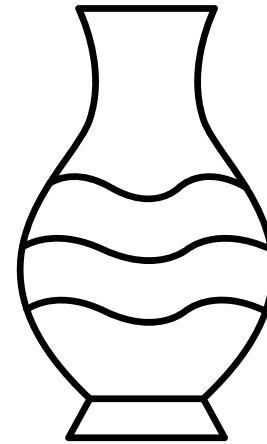
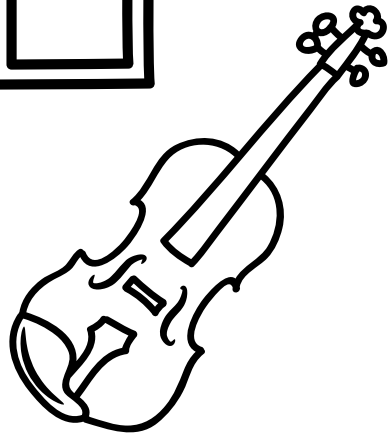
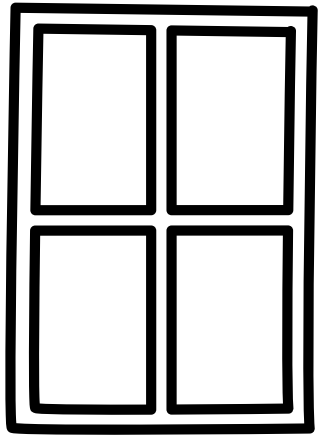

**Color the pictures that begin with the
sound of the letter X**

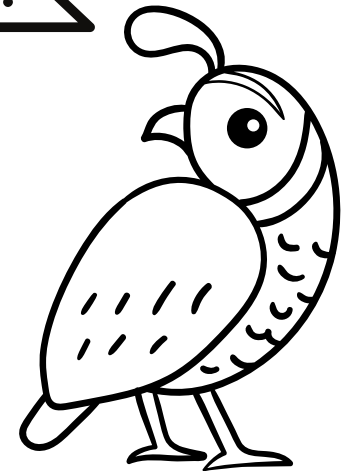
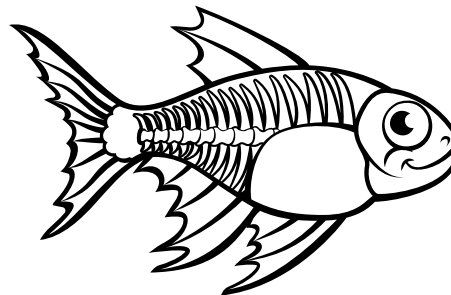
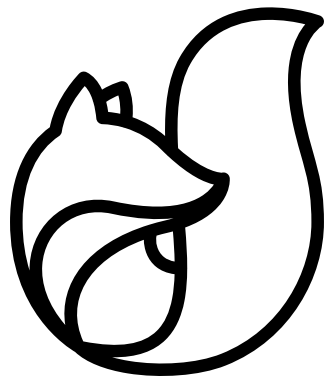
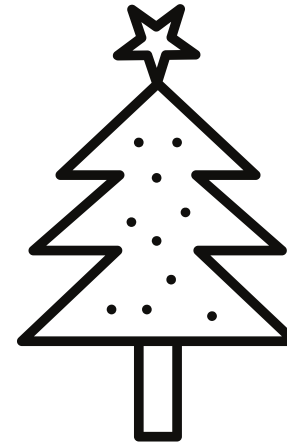
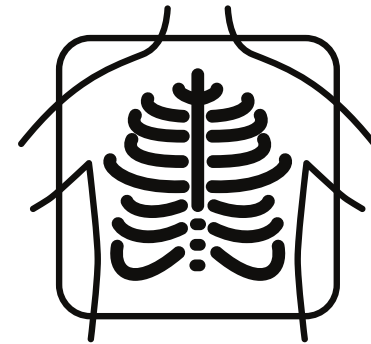
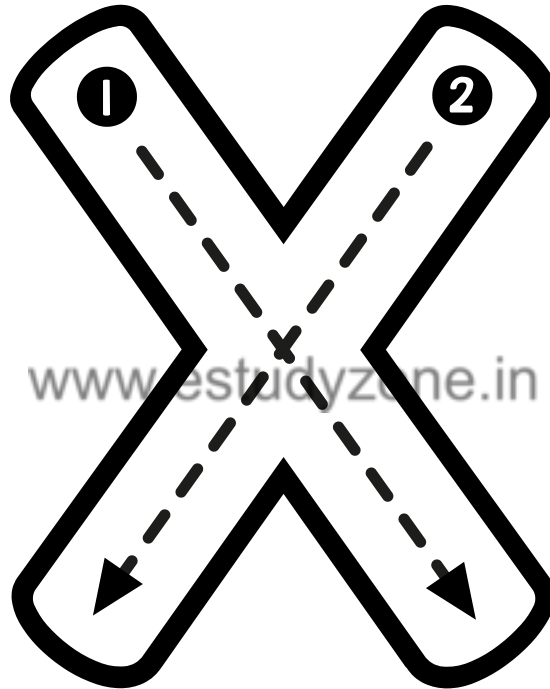
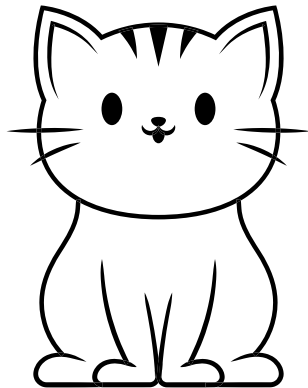
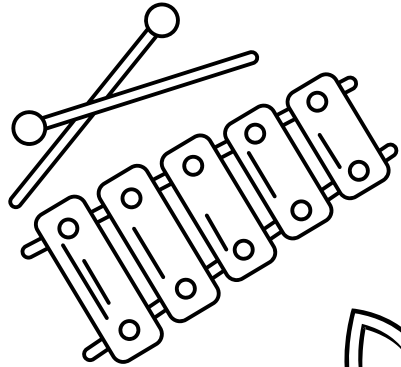

www.estudyzone.in

Color the pictures that begin with the
sound of the letter Y

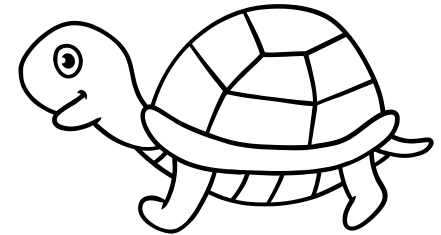
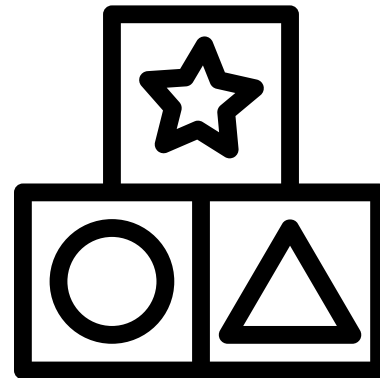
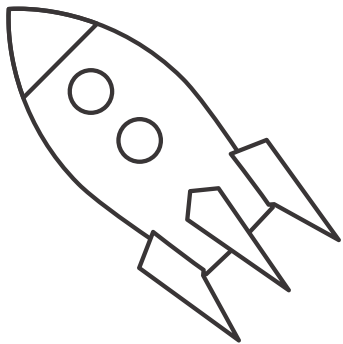
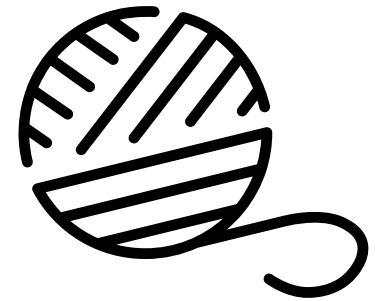
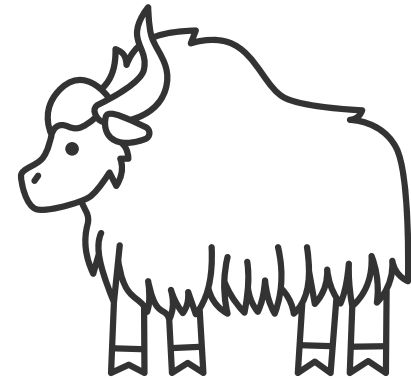
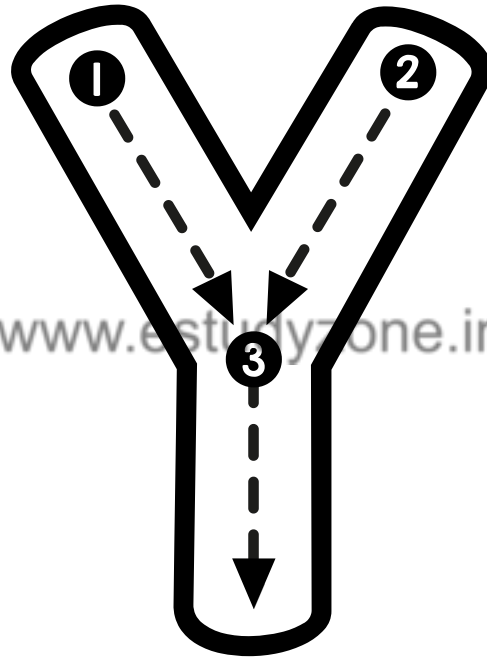
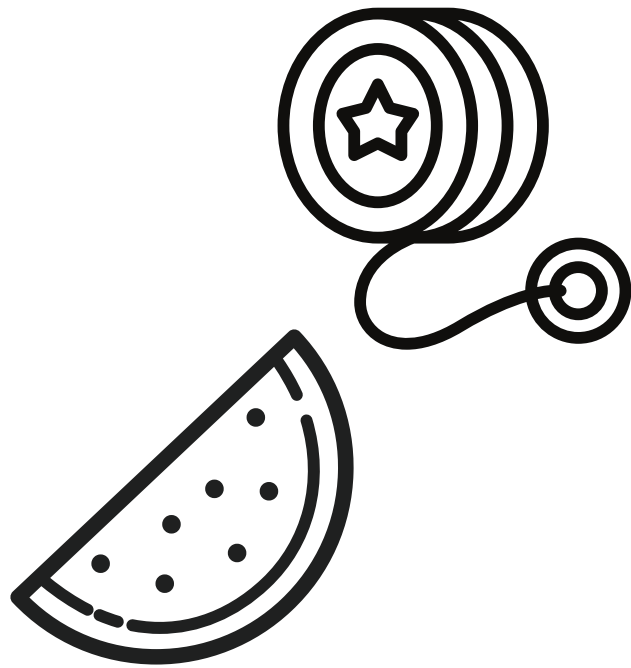

Color the pictures that begin with the
sound of the letter Z

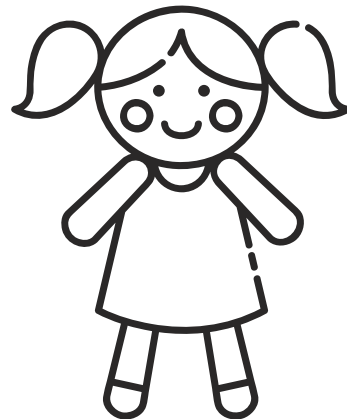
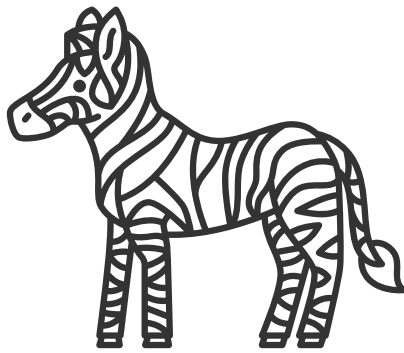
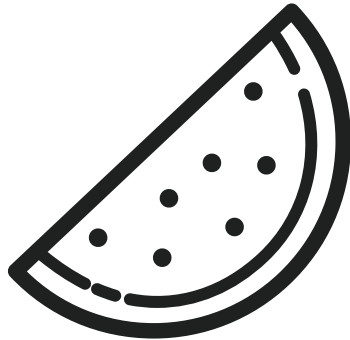
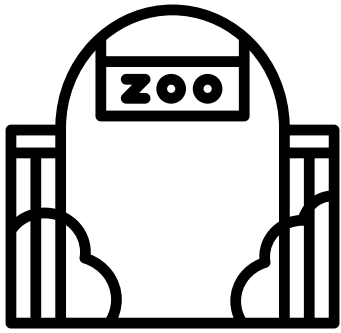

www.estudyzone.in

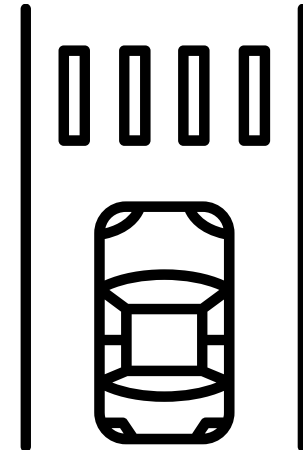
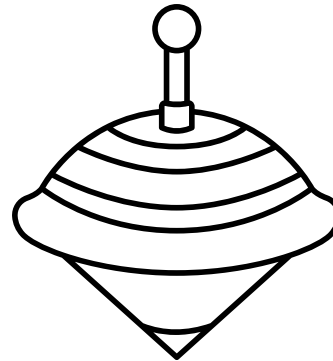
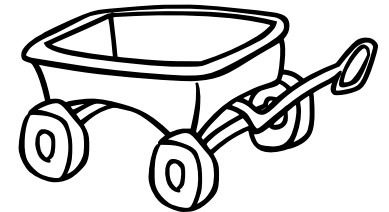
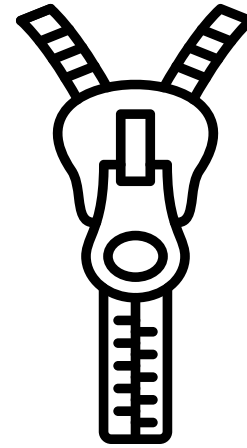

What is the begining sound ? color it

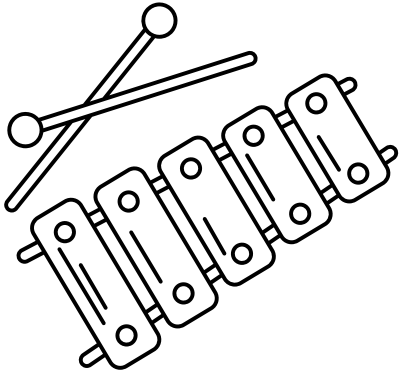

X

V

H



F

B

U

www.estudyzone.in

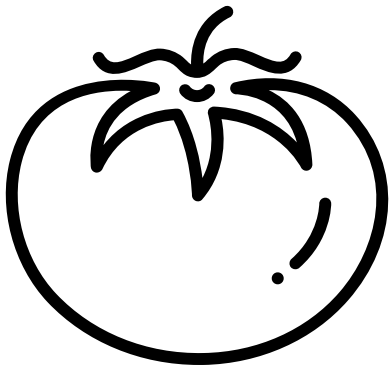

K

T

L



R

Y

O

What is the begining sound ? color it

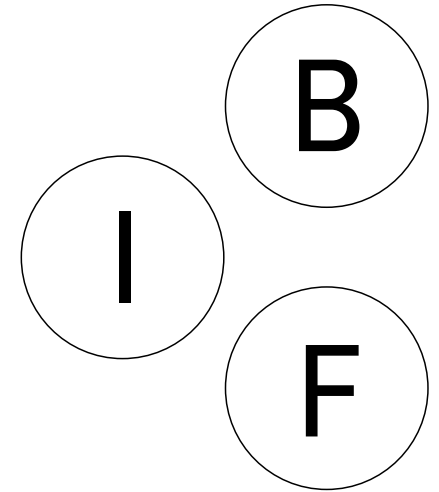
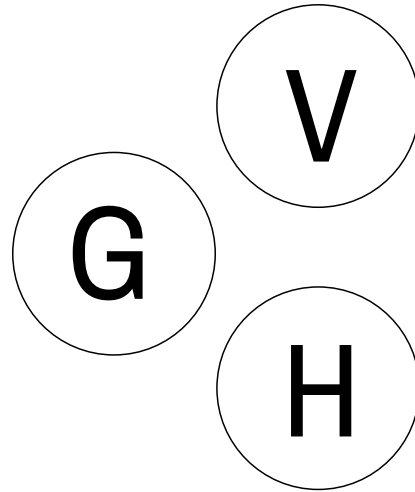
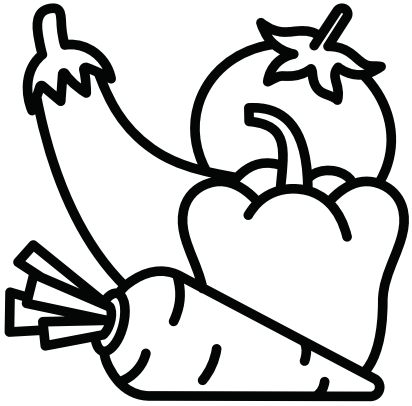

www.estudyzone.in

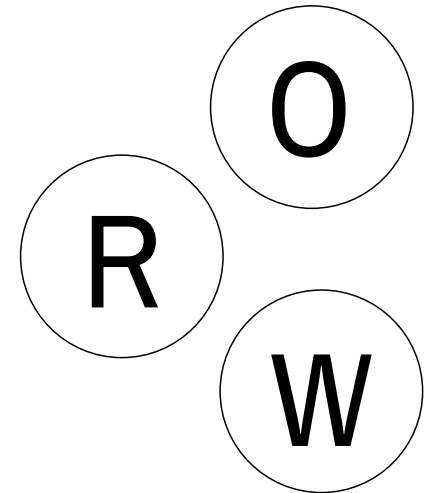
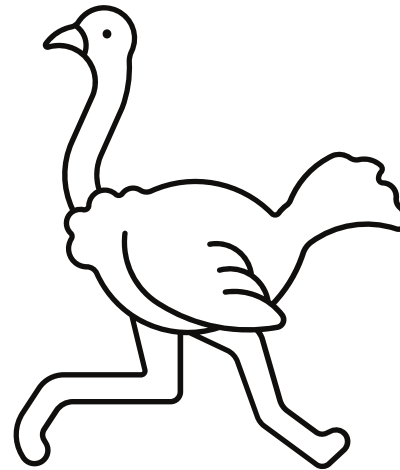
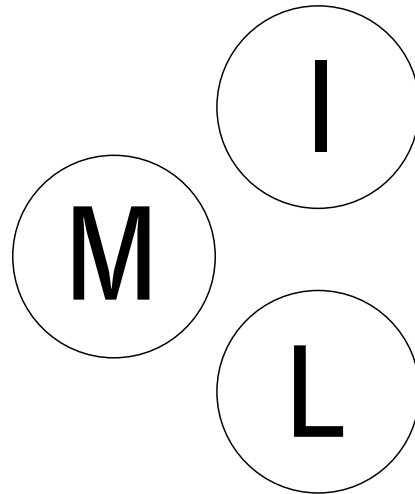

What is the begining sound ? color it

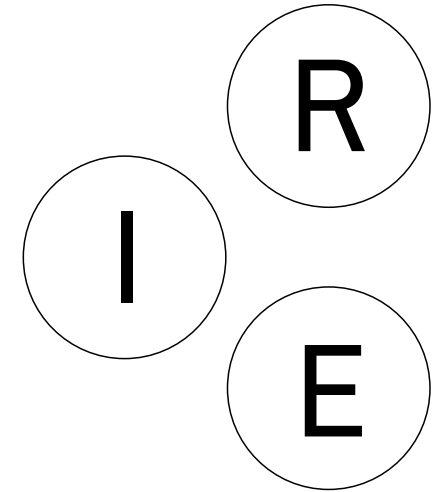
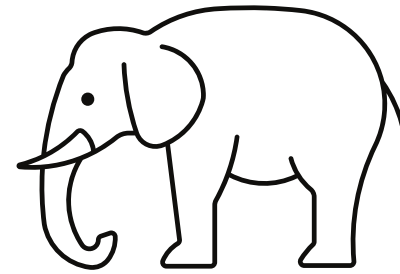
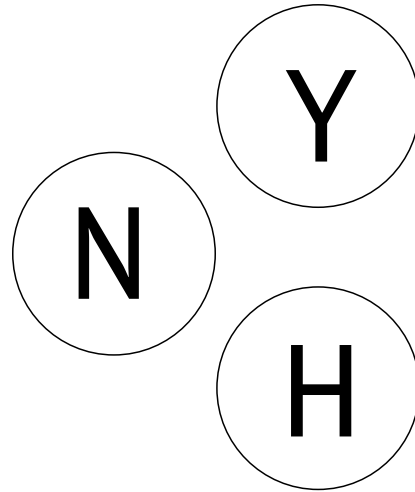

www.estudyzone.in

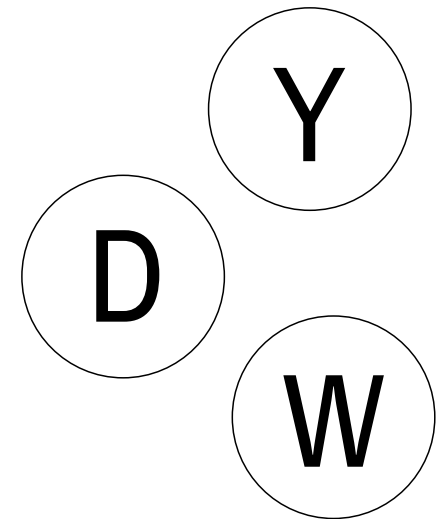
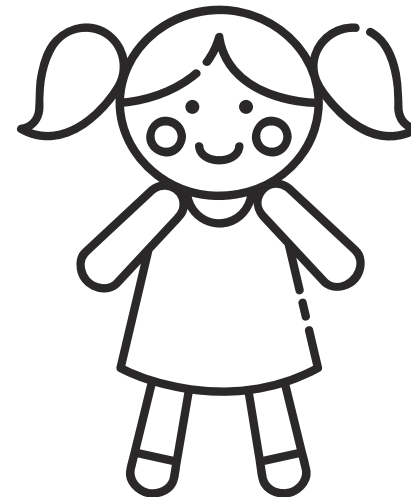
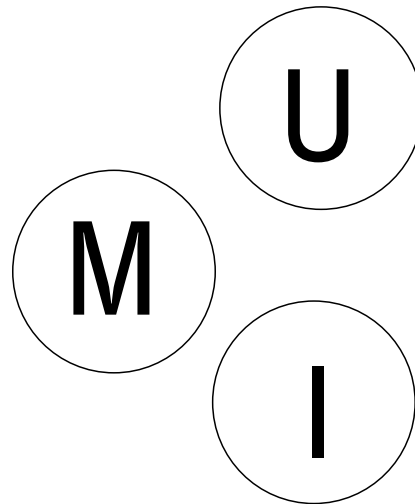
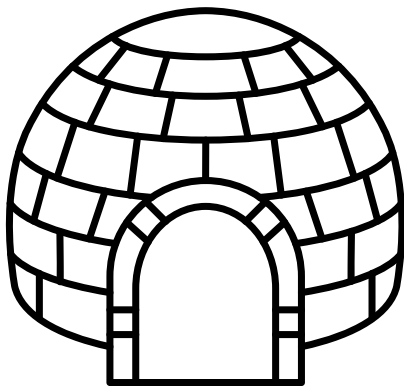

What's The Letter ?

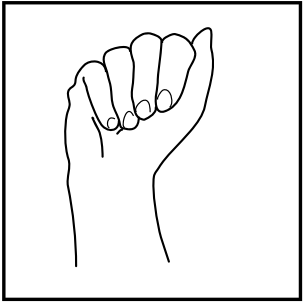

=

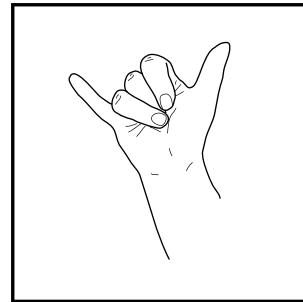
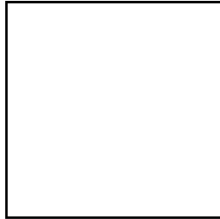

=

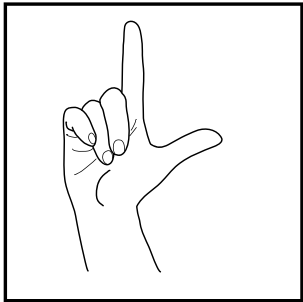
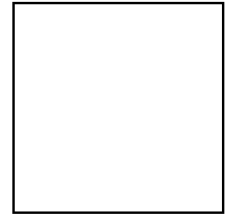

=

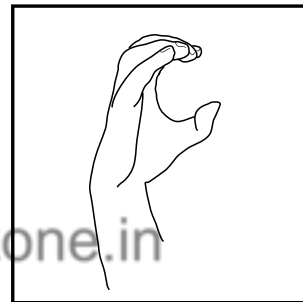

=

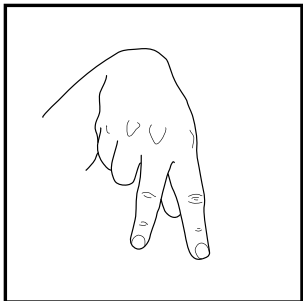
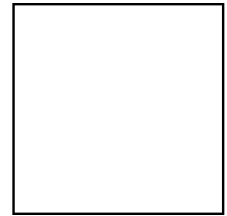

=

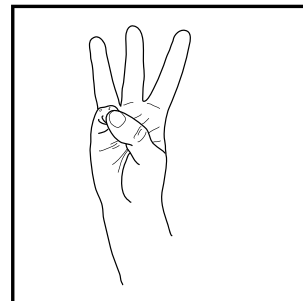
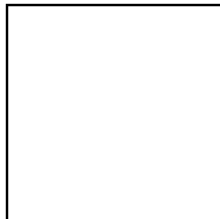

=

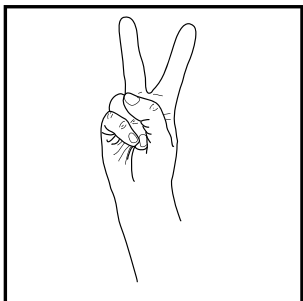
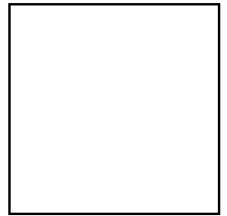

=

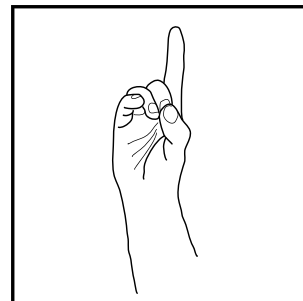
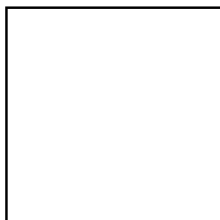

=

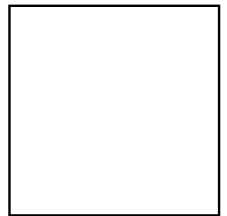

www.estudyzone.in

What's The Letter ?

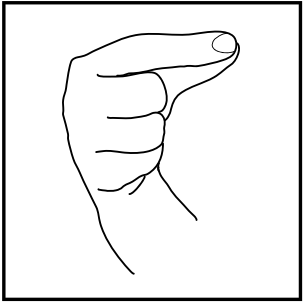

=

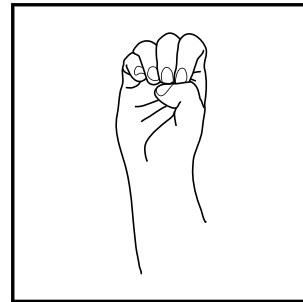
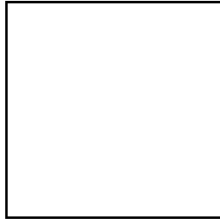

=

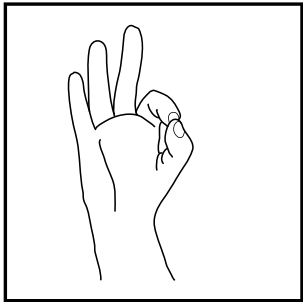
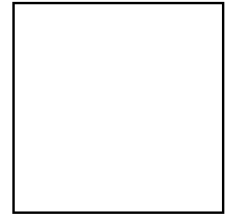

=

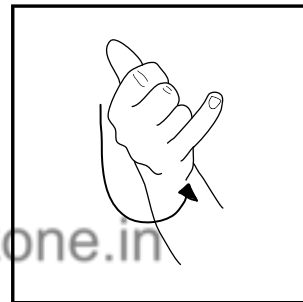

=

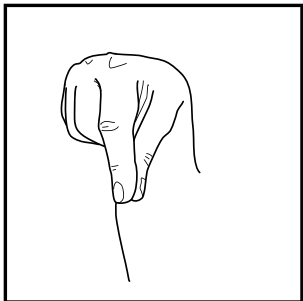
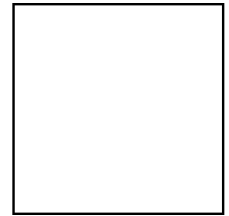

=

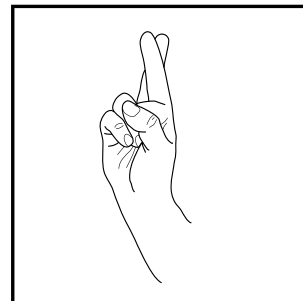
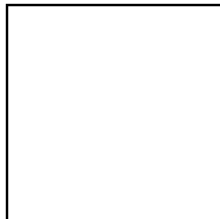

=

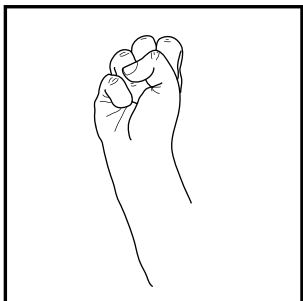
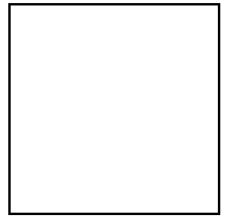

=

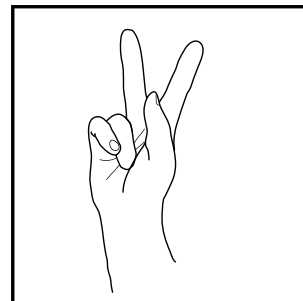
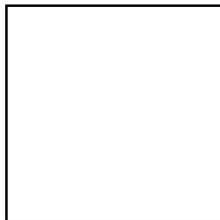

=

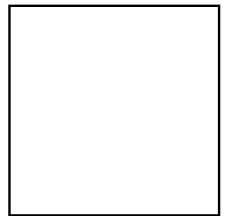

www.estudyzone.in

What's The Letter ?

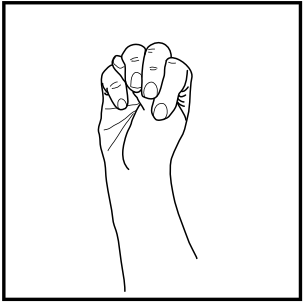

=

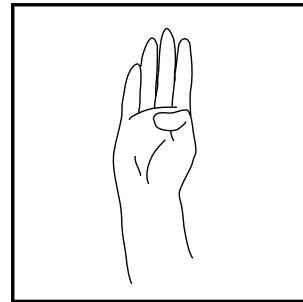
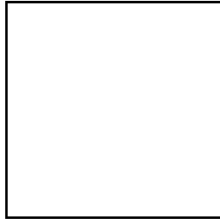

=

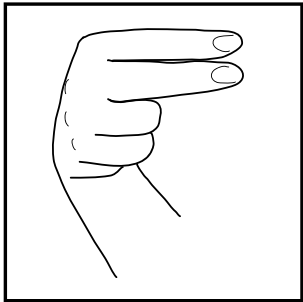
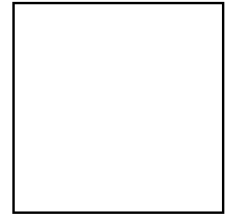

=

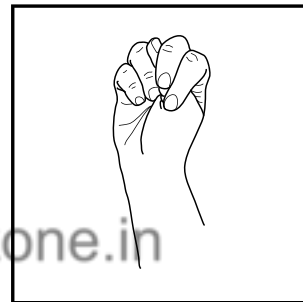

=

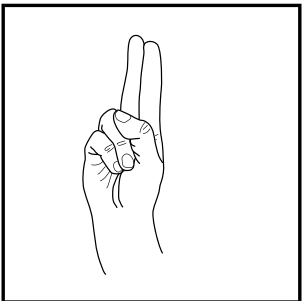
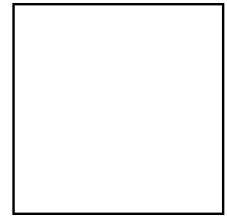

=

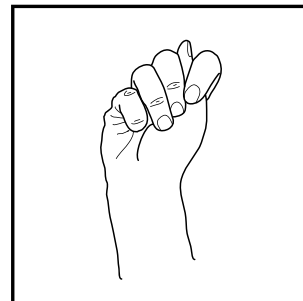
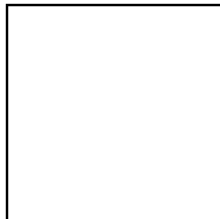

=

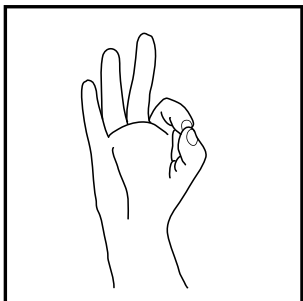
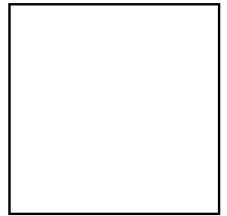

=

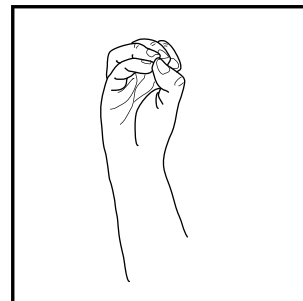
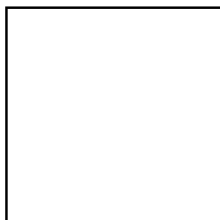

=

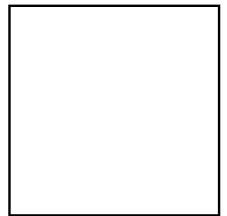

www.estudyzone.in

What starts with CH ?

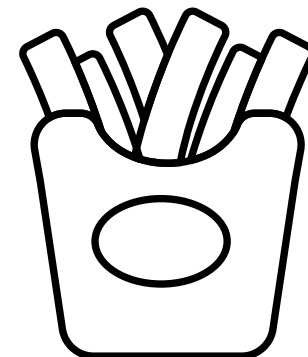
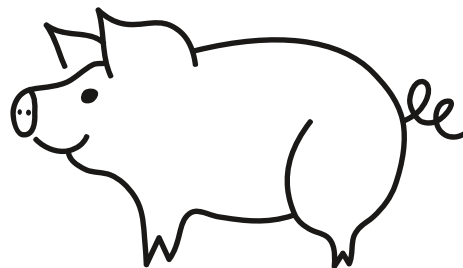
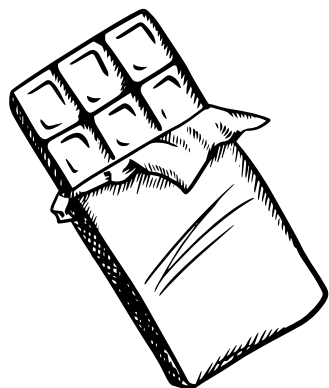
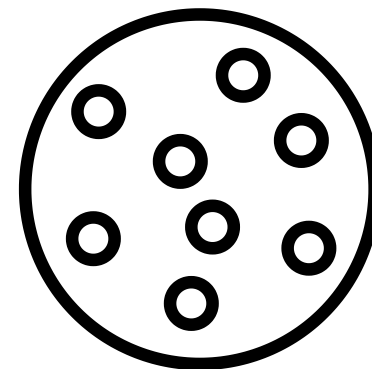
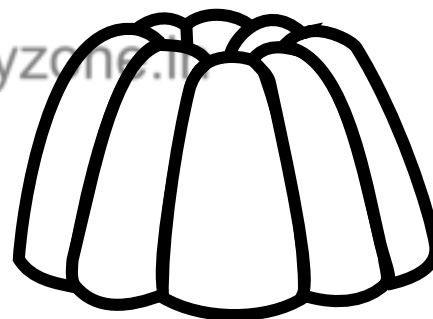
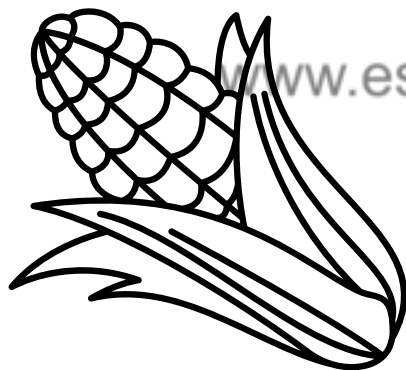
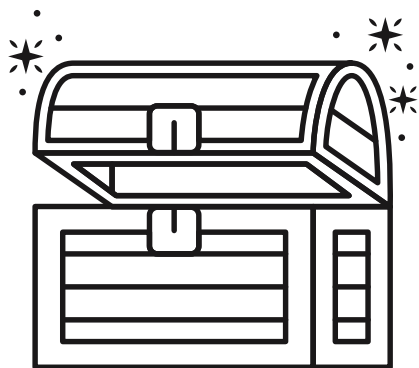
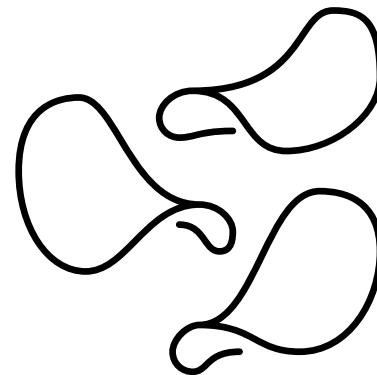
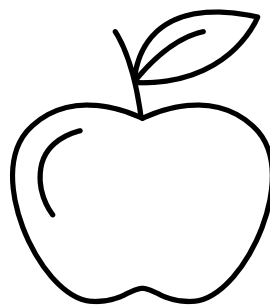
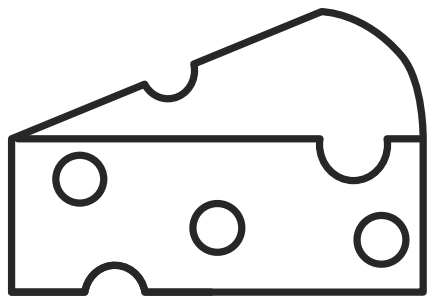
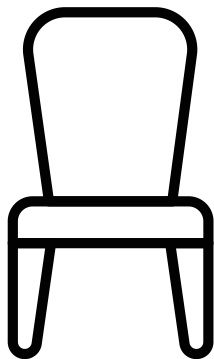

What starts with SH ?

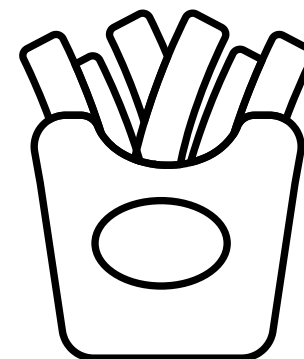
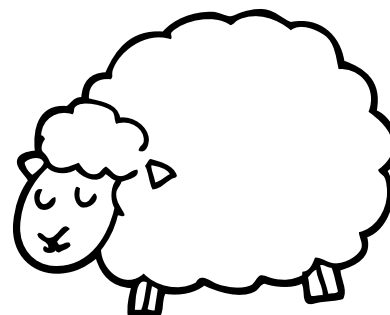
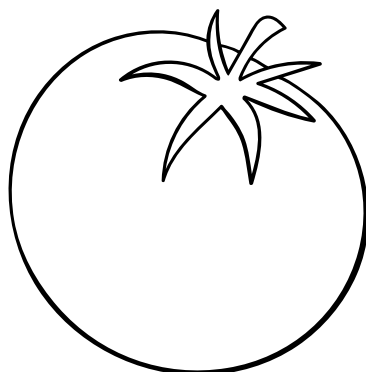
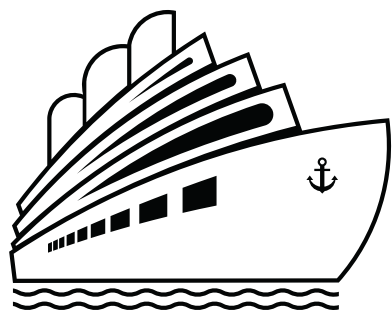
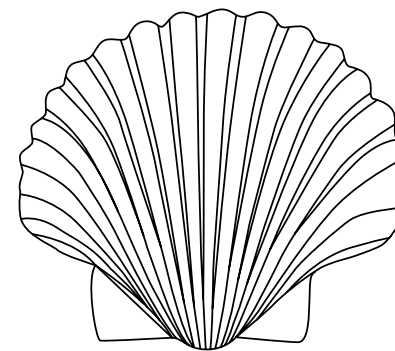
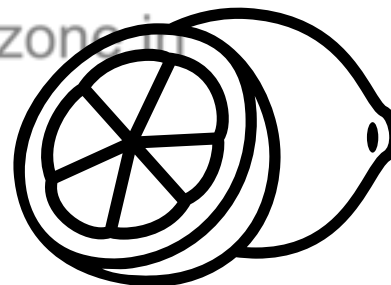
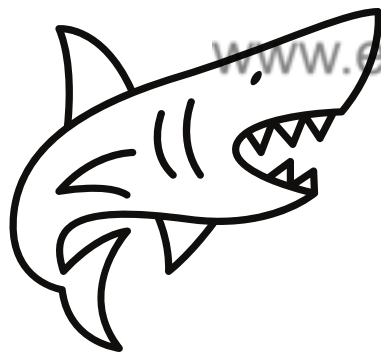
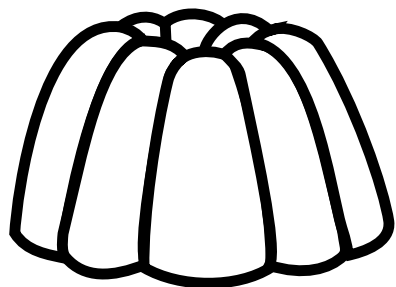
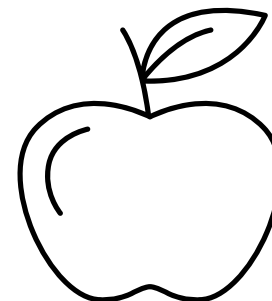
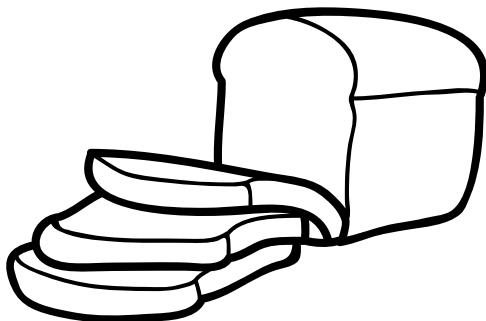

What starts with TH ?

